

# AQ/C-Turnier

**ewu**  
Erste Westernreiter Union  
Deutschland e.V.

8.—10. Juni 2018



**PROGRAMMHEFT**

**[www.seehof-reibitz.de](http://www.seehof-reibitz.de)**

# Phantastic

40 JAHRE EWU  
GALA EVENT

EWU

24/11/18

ewu

KARTENVERKAUF UND INFORMATION  
[WWW.WESTERNREITER.COM](http://WWW.WESTERNREITER.COM)

ERSTE WESTERNREITER UNION DEUTSCHLAND e.V.

## **Organisation**

|                       |   |
|-----------------------|---|
| <b>Veranstalter</b>   | Reichel UG & Co. Veranstaltungen KG,<br>Teichstr. 2 d, 04509 Löbnitz OT Reibitz   |
| <b>Turnierleiter</b>  | Heike Reichel-Grünewald   |
| <b>Richter</b>        | Susanne Haug, Birgit Bayer-Sassenhausen   |
| <b>Ringstewards</b>   | Jana Köhntopp, Simone Salzer  |
| <b>EWU-Stewards</b>   | Sascha Matz, Melanie Tauscher   |
| <b>Meldestelle</b>    | Gudrun Hellwig<br>Donnerstag 17-20 Uhr<br>Freitag 6:30 Uhr bis Ende letzte Prüfung<br>Samstag: 6:00 Uhr bis Ende letzte Prüfung<br>Sonntag 6:00 Uhr bis Ende letzte Prüfung |
| <b>Tierarzt</b>       | siehe aktueller Aushang sowie<br>Tierklinik Leipzig 0341/97 38-330  |
| <b>Turnierschmied</b> | Michael Dayß (vor Ort am Stall)   |
| <b>Arzt</b>           | Franziska Faßbinder 0173/5811207  |

### **Abreitezeiten:**

Donnerstag, Reithalle, 17-22 Uhr davon 20-21 Uhr Reiningmanöver,  
Reitplatz 17-22 Uhr

Freitag 1h vor Beginn der ersten Prüfung bis 22 Uhr, in der Reithalle von  
21-22 Uhr Reiningmanöver

Samstag 1h vor Beginn der ersten Prüfung bis 1h nach Turnierende

Sonntag 1h vor Beginn der ersten Prüfung bis Ende der letzten Prüfung

## Freitag, 08.06.2017

|              |                      |  | Dauer        | Starts | Reitplatz |
|--------------|----------------------|--|--------------|--------|-----------|
| 08:00        | LK 3A SSH            | Showmanship at Halter                      | 00:30        | 7      | Reithalle |
| 08:30        | LK 1A SSH            | Showmanship at Halter                      | 00:20        | 5      | Reithalle |
| 08:50        | LK 2A SSH            | Showmanship at Halter                      | 00:30        | 9      | Reithalle |
| 09:20        | Q LK 1/2 A SSH       | Qualifikationsklasse Showmanship at Halter | 00:50        | 14     | Reithalle |
| 10:10        | LK 4A WHS            | Western Horsemanship                       | 00:20        | 4      | Reithalle |
| 10:30        | LK 3A WHS            | Western Horsemanship                       | 00:40        | 15     | Reithalle |
| 11:10        | LK 1/2 A jun WPL     | Junior Western Pleasure                    | 00:20        | 4      | Reithalle |
| 11:40        | LK 1A sen WPL        | Senior Western Pleasure                    | 00:30        | 11     | Reithalle |
| <b>12:10</b> | <b>Pause</b>         | <b>Mittagspause</b>                        | <b>00:30</b> |        |           |
| 12:40        | LK 2A sen WPL        | Senior Western Pleasure                    | 00:30        | 14     | Reithalle |
| 13:10        | JUPF BA 4j           | Jungpferde Basis 4 jährig                  | 00:30        | 6      | Reithalle |
| 13:40        | JUPF BA 5j           | Jungpferde Basis 5 jährig                  | 00:30        | 6      | Reithalle |
| 14:10        | YOUNGSTARS Challenge | YOUNGSTARS Challenge                       | 00:20        | 4      | Reithalle |
| 14:30        | LK 3A RN             | Reining                                    | 00:40        | 8      | Reithalle |
| 15:10        | LK 1/2 B WPL         | Western Pleasure                           | 00:20        | 7      | Reithalle |

|              |                     |  |              |    |            |
|--------------|---------------------|--|--------------|----|------------|
| 09:00        | LK 3A RR            | Ranch Riding                             | 01:00        | 19 | Außenplatz |
| 10:00        | LK 1/2 jun RR       | Junior Ranch Riding                      | 00:30        | 9  | Außenplatz |
| 10:30        | LK 1A sen RR        | Senior Ranch Riding                      | 01:10        | 21 | Außenplatz |
| 11:40        | LK 2A sen RR        | Senior Ranch Riding                      | 01:00        | 17 | Außenplatz |
| <b>12:40</b> | <b>Pause</b>        | <b>Mittagspause</b>                      | <b>00:30</b> |    |            |
| 13:10        | Q LK 2/1 A sen RR   | Qualifikationsklasse Senior Ranch Riding | 01:40        | 33 | Außenplatz |
| 14:50        | Q LK 2/1 jun RR     | Qualifikationsklasse Junior Ranch Riding | 00:30        | 8  | Außenplatz |
| 15:30        | LK 1 sen SUHO       | Senior Superhorse                        | 00:40        | 8  | Außenplatz |
| 16:10        | LK 2 sen SUHO       | Senior Superhorse                        | 00:20        | 4  | Außenplatz |
| 16:30        | Q LK 2/1 A sen SUHO | Qualifikationsklasse Senior Superhorse   | 01:20        | 15 | Außenplatz |
| 17:50        | Q LK 2/1 B sen SUHO | Qualifikationsklasse Senior Superhorse   | 00:20        | 4  | Außenplatz |

## Samstag, 09.06.2017

|              |                    |  | Dauer        | Starts | Reitplatz |
|--------------|--------------------|--|--------------|--------|-----------|
| 07:00        | LK 3B SSH          | Showmanship at Halter                      | 00:30        | 7      | Reithalle |
| 07:30        | LK 4/5 SSH         | Showmanship at Halter                      | 00:20        | 4      | Reithalle |
| 07:50        | LK 1/2 B SSH       | Showmanship at Halter                      | 00:20        | 6      | Reithalle |
| 08:10        | Q LK 2/1 B SSH     | Qualifikationsklasse Showmanship at Halter | 00:20        | 5      | Reithalle |
| 08:30        | LK 4/5 RR          | Ranch Riding                               | 00:30        | 10     | Reithalle |
| 09:00        | LK 3B RR           | Ranch Riding                               | 00:40        | 13     | Reithalle |
| 09:40        | LK 1/2 B RR        | Ranch Riding                               | 00:40        | 11     | Reithalle |
| 10:20        | LK 4 RN            | Reining                                    | 00:20        | 4      | Reithalle |
| 10:40        | LK 1/2 B RN        | Reining                                    | 00:30        | 5      | Reithalle |
| 11:10        | YOUNGSTARS Reining | YOUNGSTARS Reining                         | 00:30        | 4      | Reithalle |
| 11:40        | LK 3B RN           | Reining                                    | 00:20        | 4      | Reithalle |
| <b>12:00</b> | <b>Pause</b>       | <b>Mittagspause</b>                        | <b>00:30</b> |        |           |
| 12:30        | JUPF RN 4j         | Jungpferde Reining 4 jährig                | 00:20        | 4      | Reithalle |
| 12:50        | JUPF RN 5j         | Jungpferde Reining 5 jährig                | 00:30        | 4      | Reithalle |
| 13:20        | WT Horsemanship    | Walk Trot Horsemanship                     | 00:20        | 5      | Reithalle |
| 13:40        | LK 1B WHS          | Western Horsemanship                       | 00:20        | 4      | Reithalle |
| 14:00        | LK 2B WHS          | Western Horsemanship                       | 00:20        | 8      | Reithalle |
| 14:20        | LK 1/2 jun RN      | Junior Reining                             | 00:20        | 4      | Reithalle |
| 14:40        | LK 1A sen RN       | Senior Reining                             | 00:50        | 7      | Reithalle |
| 15:30        | LK 2A sen RN       | Senior Reining                             | 00:50        | 8      | Reithalle |

|         |               |                         |       |   |           |
|---------|---------------|-------------------------|-------|---|-----------|
| 16:20   | Sonderprüfung | FN Reining Junioren     | 00:20 | 3 | Reithalle |
| 16:40   | Sonderprüfung | FN Reining junge Reiter | 00:10 | 1 | Reithalle |
| 16:50   | Sonderprüfung | FN Reining Senioren     | 00:20 | 2 | Reithalle |
| anschl. | SQ FS RN      | Freestyle Reining Cup   | 00:20 | 4 | Reithalle |

|              |                   |  |              |    |            |
|--------------|-------------------|--|--------------|----|------------|
| 07:00        | LK 1A sen TH      | Senior Trail                               | 01:10        | 17 | Außenplatz |
| 08:10        | LK 2A sen TH      | Senior Trail                               | 01:10        | 16 | Außenplatz |
| 09:20        | LK 1/2 jun TH     | Junior Trail                               | 00:20        | 5  | Außenplatz |
| 09:40        | LK 3A TH          | Trail                                      | 01:00        | 13 | Außenplatz |
| 10:40        | LK 3B TH          | Trail                                      | 00:40        | 10 | Außenplatz |
| 11:20        | LK 1B TH          | Trail                                      | 00:20        | 5  | Außenplatz |
| 11:40        | LK 2B TH          | Trail                                      | 00:30        | 7  | Außenplatz |
| <b>12:10</b> | <b>Pause</b>      | <b>Mittagspause</b>                        | <b>00:30</b> |    |            |
| 12:40        | LK 1/2 H&DTH      | Horse & Dog Trail                          | 00:20        | 4  | Außenplatz |
| 13:00        | Q LK 1/2 H&D TH   | Horse & Dog Trail                          | 00:40        | 4  | Außenplatz |
| 13:40        | LK 1A sen WR      | Senior Western Riding                      | 00:50        | 9  | Außenplatz |
| 14:30        | LK 2-3 WR         | Western Riding                             | 01:00        | 9  | Außenplatz |
| 15:30        | Q LK 2/1 B RR     | Qualifikationsklasse Ranch Riding          | 01:00        | 16 | Außenplatz |
| 16:30        | Q LK 2/1 A sen WR | Qualifikationsklasse Senior Western Riding | 01:20        | 15 | Außenplatz |
| 17:50        | Q LK 2/1 B WR     | Qualifikationsklasse Western Riding        | 00:20        | 4  | Außenplatz |

## Sonntag, 10.06.2017

|              |                    |  |       |    |           |
|--------------|--------------------|--|-------|----|-----------|
| 07:00        | LK 3A WPL          | Western Pleasure                             | 00:40 | 16 | Reithalle |
| 07:50        | LK 3B WPL          | Western Pleasure                             | 00:20 | 9  | Reithalle |
| 08:10        | Q LK 2/1 A jun WPL | Qualifikationsklasse Junior Western Pleasure | 00:20 | 5  | Reithalle |
| 08:30        | Q LK 2/1 B WPL     | Qualifikationsklasse Western Pleasure        | 00:20 | 5  | Reithalle |
| 08:50        | Q LK 2/1 A sen WPL | Qualifikationsklasse Senior Western Pleasure | 00:50 | 19 | Reithalle |
| 09:40        | Q LK 2/1 B RN      | Qualifikationsklasse Reining                 | 00:20 | 4  | Reithalle |
| 10:00        | LK 4/5 WPL         | Western Pleasure                             | 00:30 | 12 | Reithalle |
| 10:30        | WT Pleasure        | Walk Trot Pleasure                           | 00:20 | 4  | Reithalle |
| 10:50        | Q LK 2/1 jun RN    | Qualifikationsklasse Junior Reining          | 00:20 | 4  | Reithalle |
| 11:10        | Q LK 2/1 B WHS     | Qualifikationsklasse Western Horsemanship    | 00:30 | 9  | Reithalle |
| <b>11:40</b> | <b>Pause</b>       | <b>Mittagspause</b>                          |       |    |           |
| 12:10        | FZ                 | Führzügelklasse                              | 00:20 | 8  | Reithalle |
| 12:30        | LK 2A WHS          | Western Horsemanship                         | 00:40 | 17 | Reithalle |
| 13:10        | LK 1A WHS          | Western Horsemanship                         | 00:40 | 19 | Reithalle |
| 13:50        | Q LK 2/1 A WHS     | Qualifikationsklasse Western Horsemanship    | 01:00 | 29 | Reithalle |
| anschl.      | Q LK 2/1 A sen RN  | Qualifikationsklasse Senior Reining          | 01:10 | 14 | Reithalle |

|              |                   |                                   |              |    |            |
|--------------|-------------------|-----------------------------------|--------------|----|------------|
| 07:00        | JUPF TH 4j        | Jungpferde Trail 4 jährig         | 00:40        | 7  | Außenplatz |
| 07:40        | JUPF TH 5j        | Jungpferde Trail 5 jährig         | 00:40        | 5  | Außenplatz |
| 08:20        | LK 5 TH           | Trail                             | 00:20        | 4  | Außenplatz |
| 08:40        | LK 4A TH          | Trail                             | 00:40        | 8  | Außenplatz |
| 09:20        | LK 4B TH          | Trail                             | 00:20        | 4  | Außenplatz |
| 09:40        | WT Trail          | Walk Trot Trail                   | 00:20        | 5  | Außenplatz |
| 10:00        | Q LK 2/1 A sen TH | Qualifikationsklasse Senior Trail | 01:50        | 27 | Außenplatz |
| 11:50        | Q LK 2/1 jun TH   | Qualifikationsklasse Junior Trail | 00:20        | 4  | Außenplatz |
| <b>12:10</b> | <b>Pause</b>      | <b>Mittagspause</b>               | <b>00:30</b> |    |            |
| 12:40        | Q LK 2/1 B TH     | Qualifikationsklasse Trail        | 00:40        | 6  | Außenplatz |
| 13:20        | LK 4/5 B WHS      | Western Horsemanship              | 00:20        | 8  | Außenplatz |
| 13:40        | LK 3B WHS         | Western Horsemanship              | 00:30        | 9  | Außenplatz |

**Mensch.  
Tier.  
Wir.**

[www.uelzener.de](http://www.uelzener.de)

**Uelzener**   
VERSICHERUNGEN **Mensch. Tier. Wir.**

## Pattern

|                      |                                |        |
|----------------------|--------------------------------|--------|
| Reining:             | LK 4                           | Pt. 15 |
|                      | LK 3 A, B                      | Pt. 11 |
|                      | LK 2 A sen., LK 1 A sen.       | Pt. 12 |
|                      | LK 1/2 jun.                    | Pt. 5  |
|                      | LK 1/2 B                       | Pt. 8  |
|                      | Q-LK 2/1 jun.                  | Pt.12  |
|                      | Q-LK 2/1 B                     | Pt.12  |
|                      | Q-LK 2/1 A sen.                | Pt. 11 |
|                      | FN Junioren                    | Pt. 6  |
|                      | FN Junge Reiter, Senioren      | Pt. 9  |
| Western Riding:      | LK 2-3 A/B                     | Pt. 8  |
|                      | LK 1 A sen.                    | Pt.4   |
|                      | Q-LK 2/1 A sen                 | Pt. 3  |
|                      | Q-LK 2/1 B                     | Pt. 3  |
| Superhorse:          | LK 1 A, LK 2 A ,LK 1 B, LK 2 B | Pt. 5  |
|                      | Q-LK 2/1 A/B                   | Pt. 3  |
| Jungpferdeprüfungen: | Basis 4 jährig                 | Pt. 3  |
|                      | Basis 5 jährig                 | Pt. 4  |
|                      | Trail 4 jährig                 | Pt. 4  |
|                      | Trail 5 jährig                 | Pt. 5  |
|                      | Reining 4 und 5 jährig         | Pt. 1  |
| Youngstar:           | Reining                        | Pt. 8  |
|                      | Challenge                      | Pt. 1  |

Ranch Riding LK 4 A, LK 4 B, LK 5 A, LK 5 B

Pattern RR 2017 #3: LK 4/5 A/B  
(auch für Hallen und Plätze 20x40m)

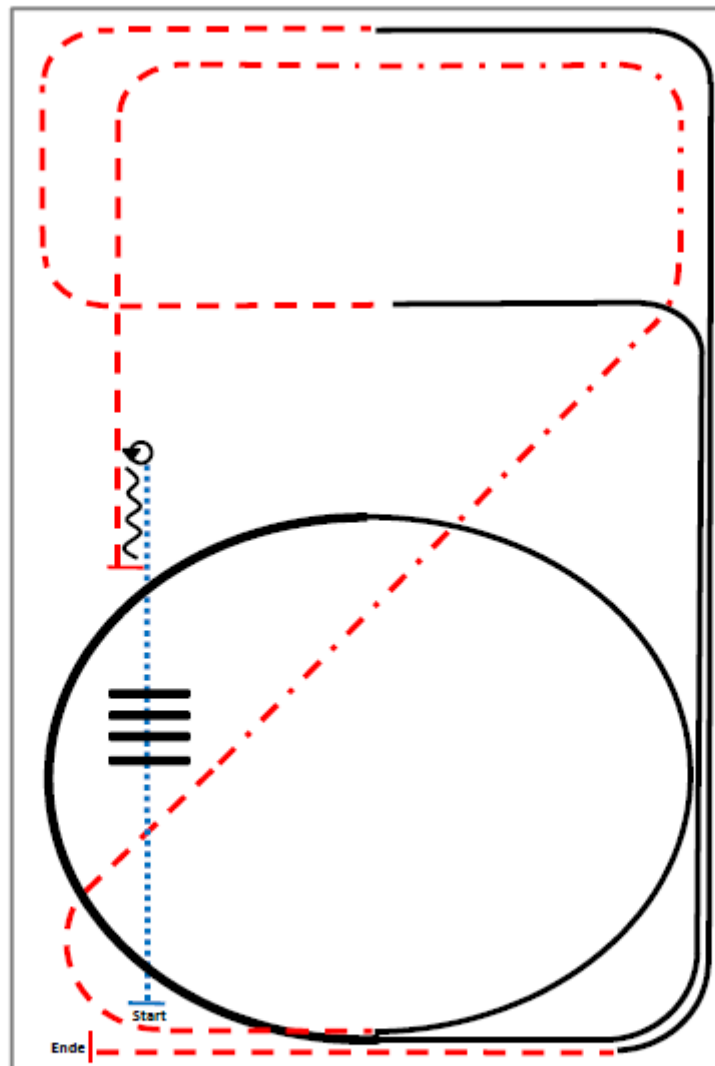

- 1) Walk.
- 2) Walk over, walk.
- 3) Stop, 360° turn left or right.
- 4) Back.
- 5) Trot.
- 6) Extended trot, trot.
- 7) Lope left lead.
- 8) Extended lope, lope.
- 9) Trot.
- 10) Lope right lead.
- 11) Trot, stop.

|  |                              |
|--|------------------------------|
|  | Back                         |
|  | Lope                         |
|  | Ext. Lope                    |
|  | Trot                         |
|  | Ext. Trot                    |
|  | Walk                         |
|  | Lead change<br>flying/simple |



# A Ranch Riding LK 3 A, LK 3 B

## Pattern RR 2017 #1: LK 3 A/B (auch für Hallen und Plätze 20x40m geeignet)



03/2017

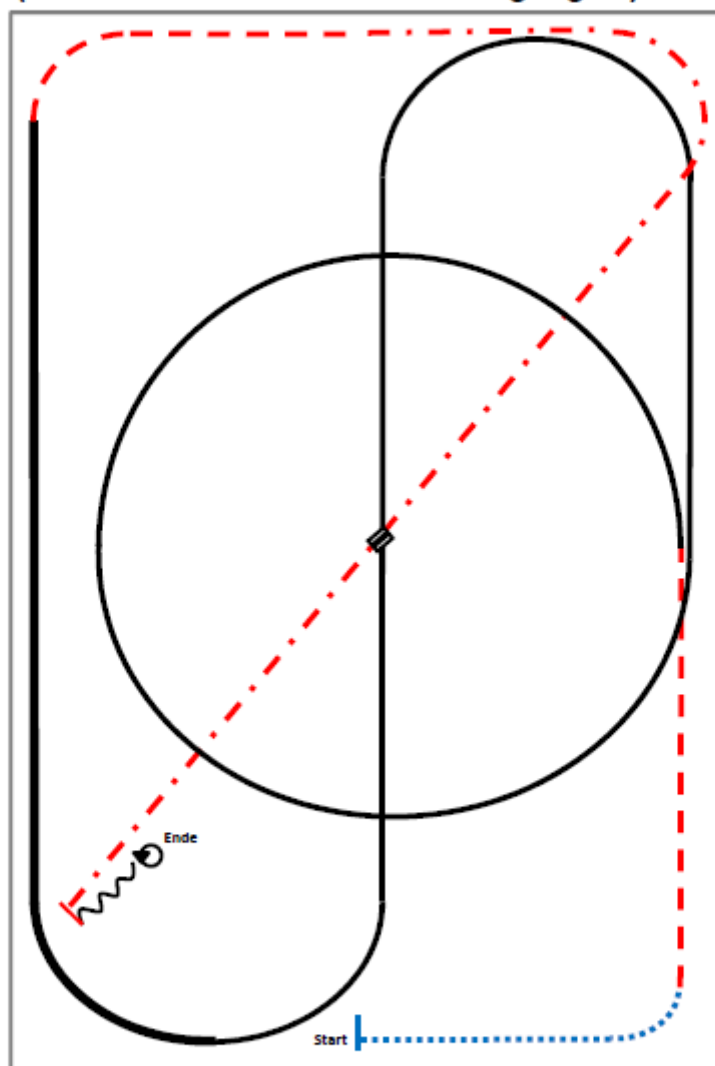

- 1) Walk.
- 2) Trot.
- 3) Lope left lead circle, lope.
- 4) Lead change in the center.
- 5) Lope right lead.
- 6) Extended lope.
- 7) Trot.
- 8) Extended trot.
- 9) Stop, back.
- 10) 360° turns each direction either way first.

|  |                              |
|--|------------------------------|
|  | Back                         |
|  | Lope                         |
|  | Ext. Lope                    |
|  | Trot                         |
|  | Ext. Trot                    |
|  | Walk                         |
|  | Lead change<br>flying/simple |

Ranch Riding LK 1 A sen., LK 2 A sen., LK 1/2 B

**Qualifikationspattern RR 2017 #6: LK 1/2 A/B sen.**  
 (auch für Hallen und Plätze 20x40m geeignet)

DFV  
 03/2017

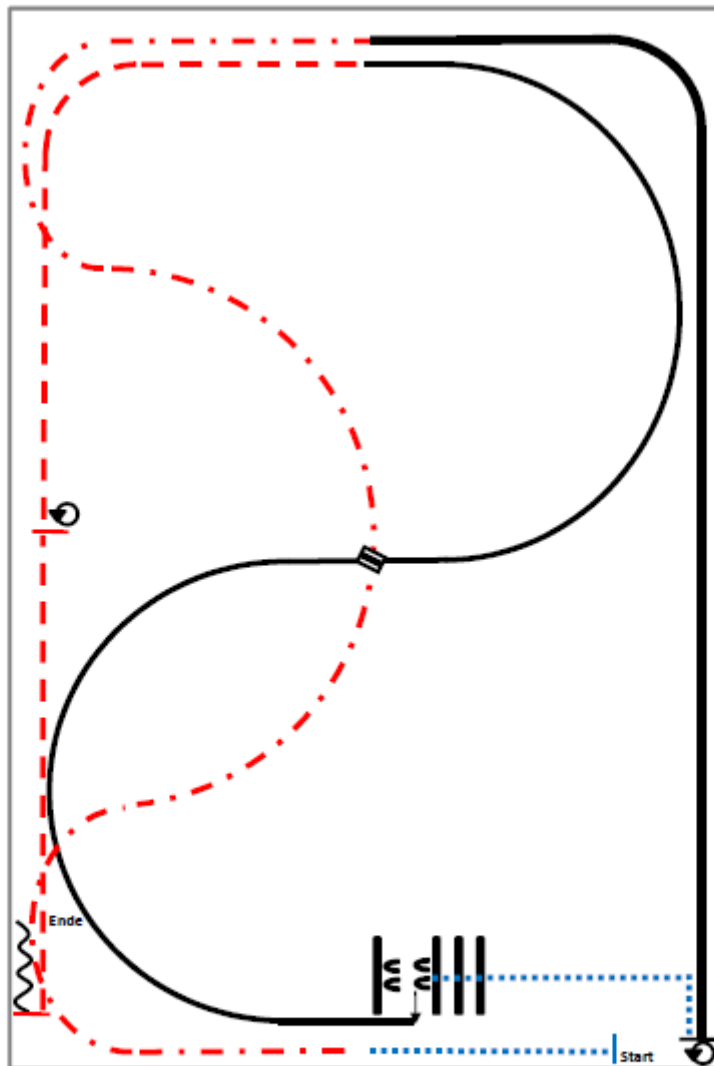

- 1) Walk.
- 2) Extended trot serpentine.
- 3) Extended lope right lead.
- 4) Stop, 180° turn right.
- 5) Walk.
- 6) Walk over, sidepass left.
- 7) Lope right lead.
- 8) Lead change.
- 9) Lope left lead.
- 10) Trot.
- 11) Stop, 360° turns each direction either way first.
- 12) Trot, stop, back.

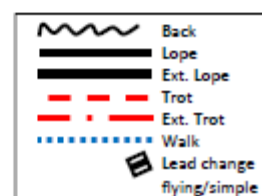

Ranch Riding LK 1 jun ,LK 2 jun.

**Qualifikationspattern RR 2017 #1: LK 1/2 jun.  
(auch für Hallen und Plätze 20x40m geeignet)**

**EWU**  
Einer-Weltreiterverband  
Deutschland e.V.  
03/2017

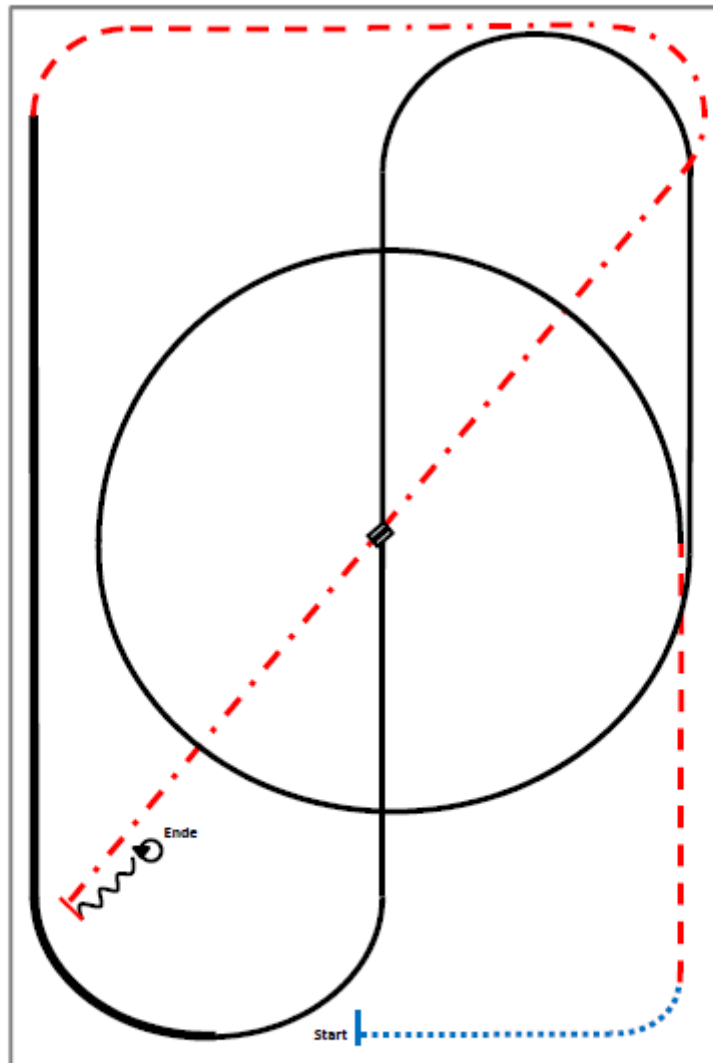

- 1) Walk.
- 2) Trot.
- 3) Lope left lead circle, lope.
- 4) Lead change in the center.
- 5) Lope right lead.
- 6) Extended lope.
- 7) Trot.
- 8) Extended trot.
- 9) Stop, back.
- 10) 360° turns each direction either way first.

|  |                              |
|--|------------------------------|
|  | Back                         |
|  | Lope                         |
|  | Ext. Lope                    |
|  | Trot                         |
|  | Ext. Trot                    |
|  | Walk                         |
|  | Lead change<br>flying/simple |

# Ranch Riding Q-LK 2/1 A, Q-LK 2/1 B

## Qualifikationspattern RR 2017 #5: LK 1/2 A/B sen. (auch für Hallen und Plätze 20x40m geeignet)

DFV  
Deutscher Reitverband  
03/2017

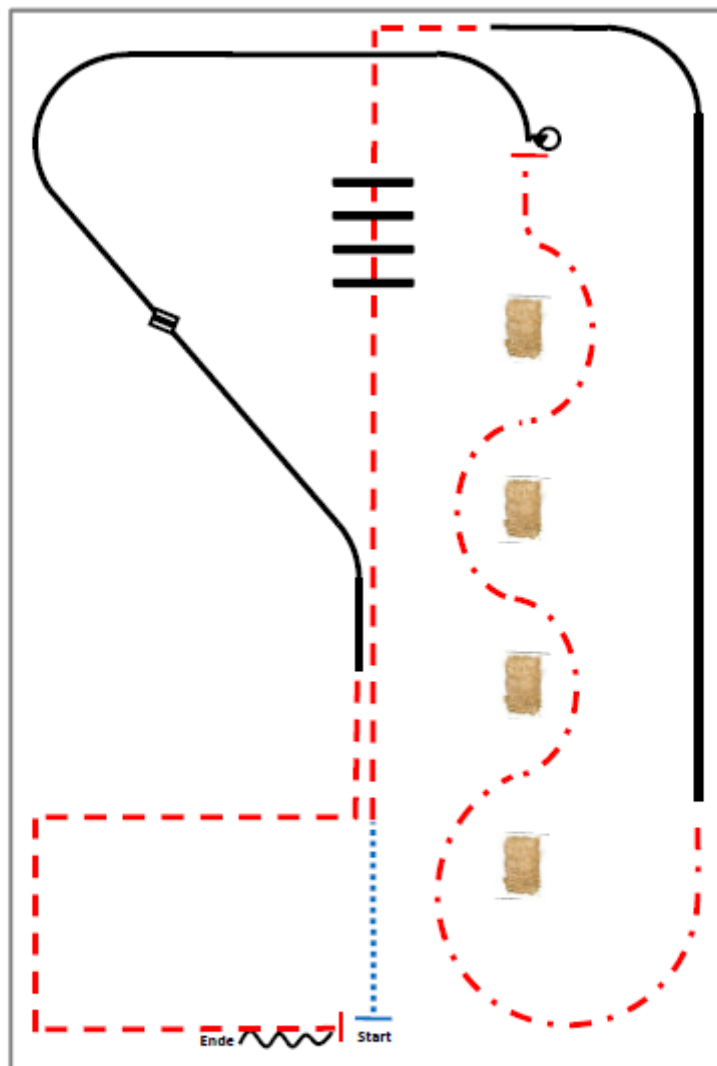

- 1) Walk.
- 2) Trot.
- 3) Trot over.
- 4) Lope right lead, extended lope.
- 5) Extended trot serpentines.
- 6) Stop, 360° turns each direction either way first.
- 7) Lope left lead.
- 8) Lead change.
- 9) Lope right lead.
- 10) Trot corners.
- 11) Stop, back.

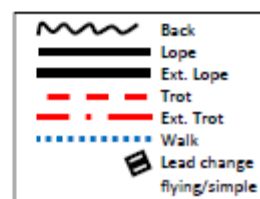

Ranch Riding Q-LK 2/1 jun.

Qualifikationspattern RR 2017 #3: LK 1/2 jun.  
(auch für Hallen und Plätze 20x40m geeignet)

DFV  
Deutscher Reitverband  
03/2017

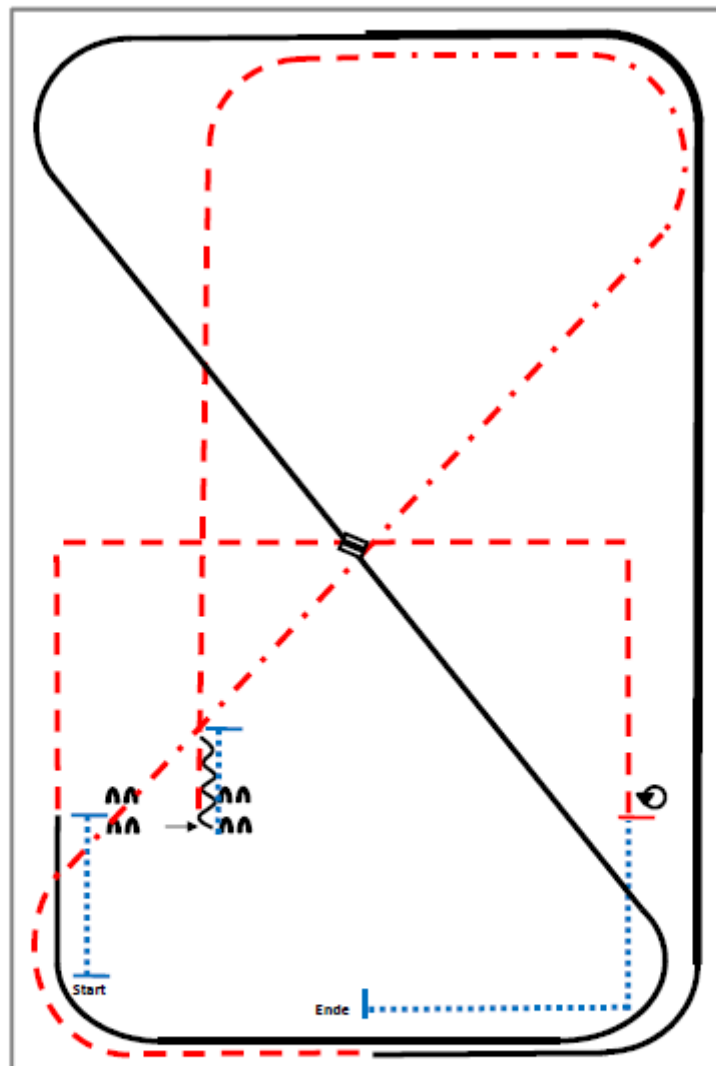

- 1) Walk, stop.
- 2) Sidepass right.
- 3) Walk, stop, back.
- 4) Trot.
- 5) Extended trot, trot.
- 6) Lope left lead.
- 7) Extended lope, lope.
- 8) Lead change.
- 9) Lope right lead.
- 10) Trot corners.
- 11) Stop, 360° turn left or right, walk, stop.

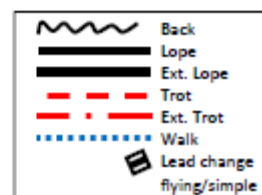

# Western Horsemanship

WT

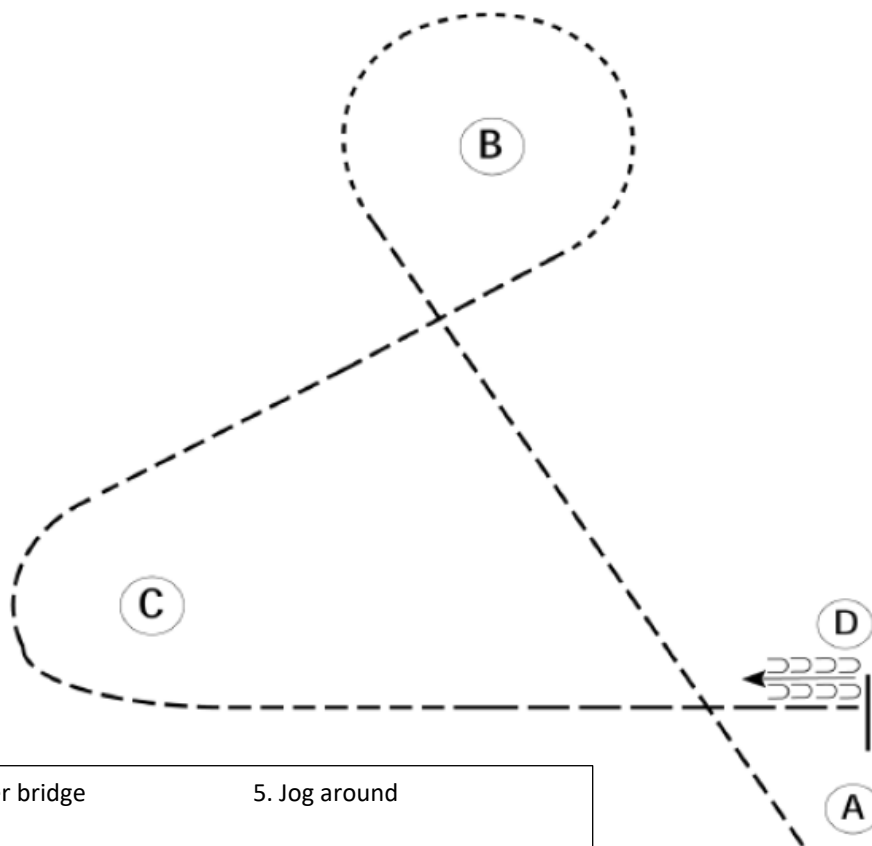

- |                            |               |
|----------------------------|---------------|
| 1. Walk over bridge        | 5. Jog around |
| 2. Walk, back up, walk out | 6. Jog over   |
| 3. Jog over                | 7. Walk, gate |
| 4. Walk in 360° r. or l.   |               |

Be ready at A.

1. Jog to B.
2. At B, walk and walk around B.
3. Jog to and around C and to D.
4. Stop at D and back approximately one horse length.

## Western Horsemanship

LK 5 A, LK 5 B, LK 4 A, LK 4 B

I

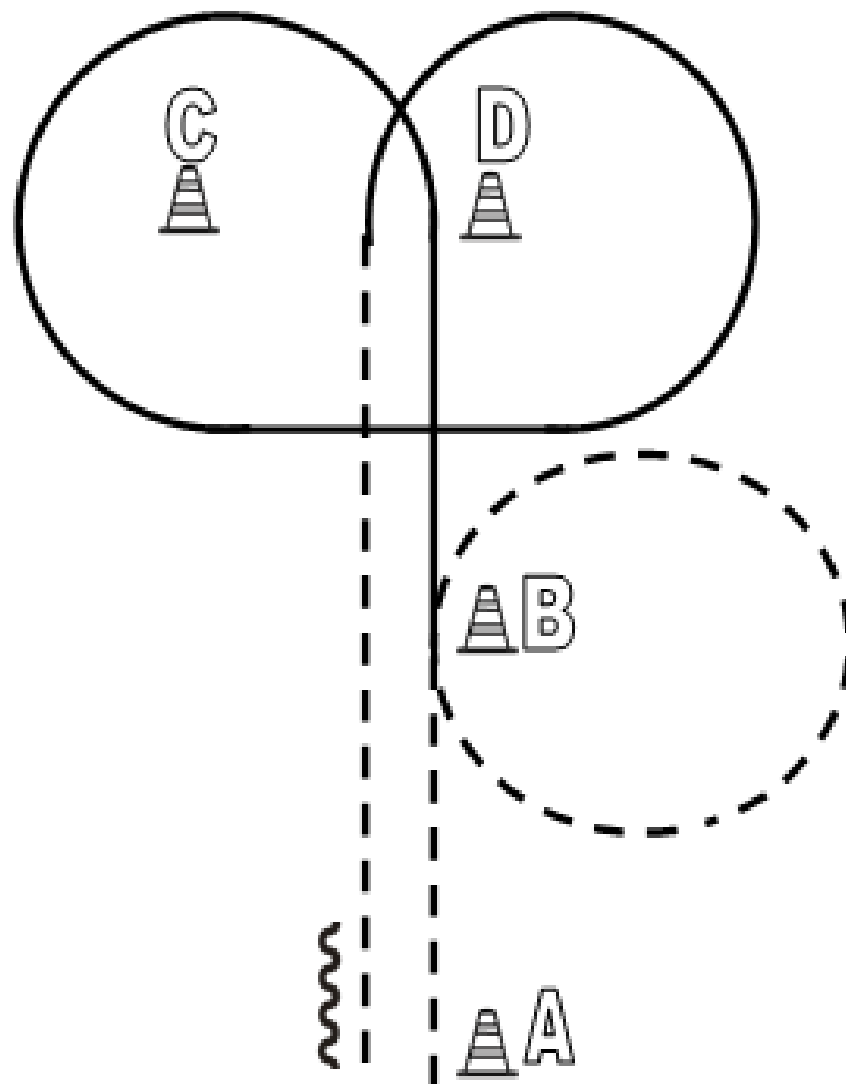

Be ready at A

1. Jog, ~~Jog~~volte
2. Lope left
3. Jog
4. Stop
5. Back up

Walk to the warmup area

# Western Horsemanship

LK 3 A, LK 3 B

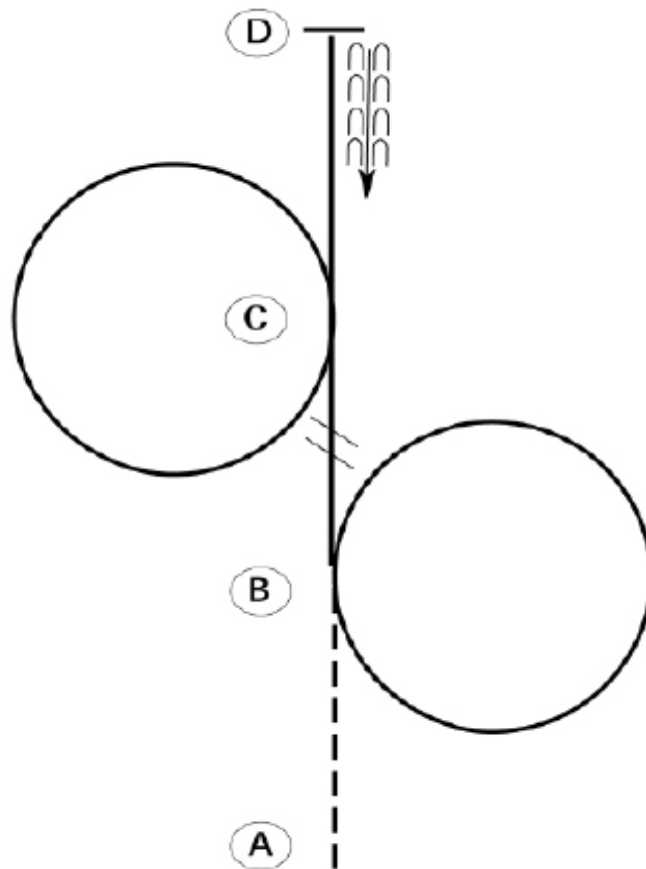

Be ready at A.

1. Jog from A to B.
2. Lope a circle to the right at B.
3. Change leads 1/2 way between B and C.
4. Lope a circle to the left at C.
5. Continue to lope to D.
6. Stop at D and back one horse length.



# Western Horsemanship

LK 1 B, LK 2 B, LK 2 A, LK 1 A

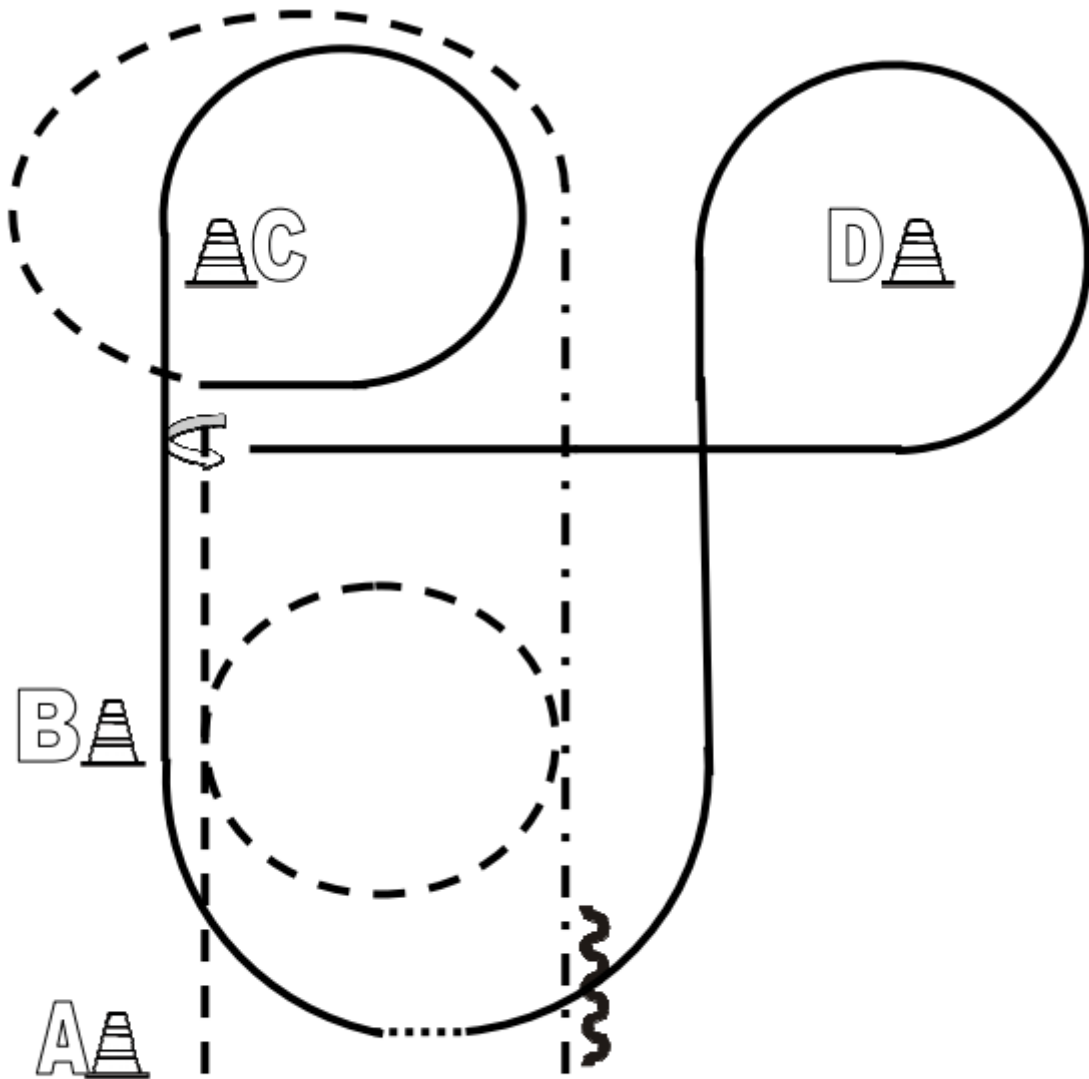

Be ready at A





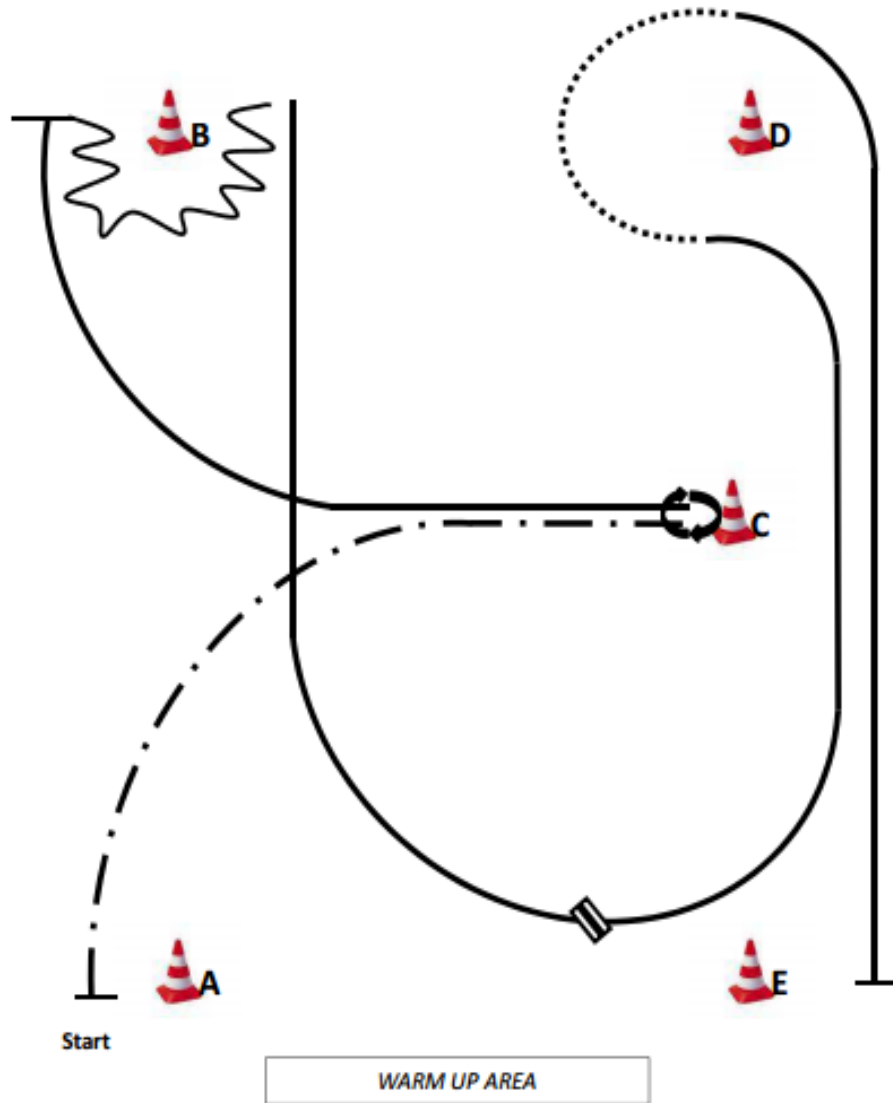

1. Jog, jog a small circle, stop
2. 270° turn left
3. Lope left lead
4. Walk
5. Lope right lead
6. Jog, extended jog
7. Stop, back

# Western Horsemanship

Q – LK 2/1 A, Q – LK 2/1 B



1. Be ready at A, ext. jog to C, stop, 540° turn (opt. r/l), right lope, stop
2. Back around B, left lope, lead change, right lope.
3. Walk, left lope to E, stop.  
Walk to warm up area.

|   |                              |
|---|------------------------------|
|  | Back                         |
|  | Lope                         |
|  | Jog                          |
|  | Ext. Jog                     |
|  | Walk                         |
|  | Lead change<br>flying/simple |

## Showmanship at Halter

LK 3 A, LK 3 B, LK 4/5 A/B

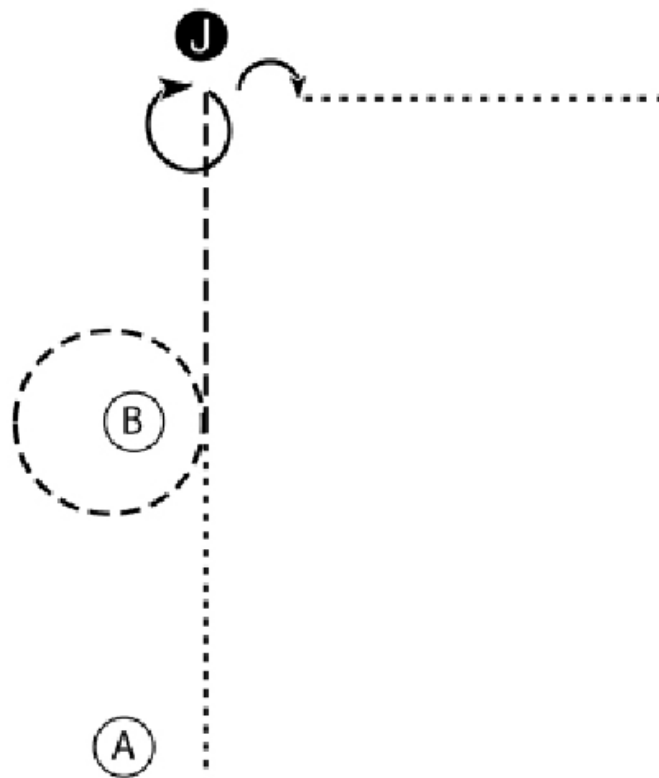

1. Walk from A to B.
2. At B trot. Trot a circle around B and continue to the Judge
3. Stop and perform a 360 degree turn. Set up for inspection.
4. When dismissed perform a 90 degree turn.
5. Walk straight away from the Judge.

## Showmanship at Halter

LK 2 A, LK 1 A, LK 1/2 B

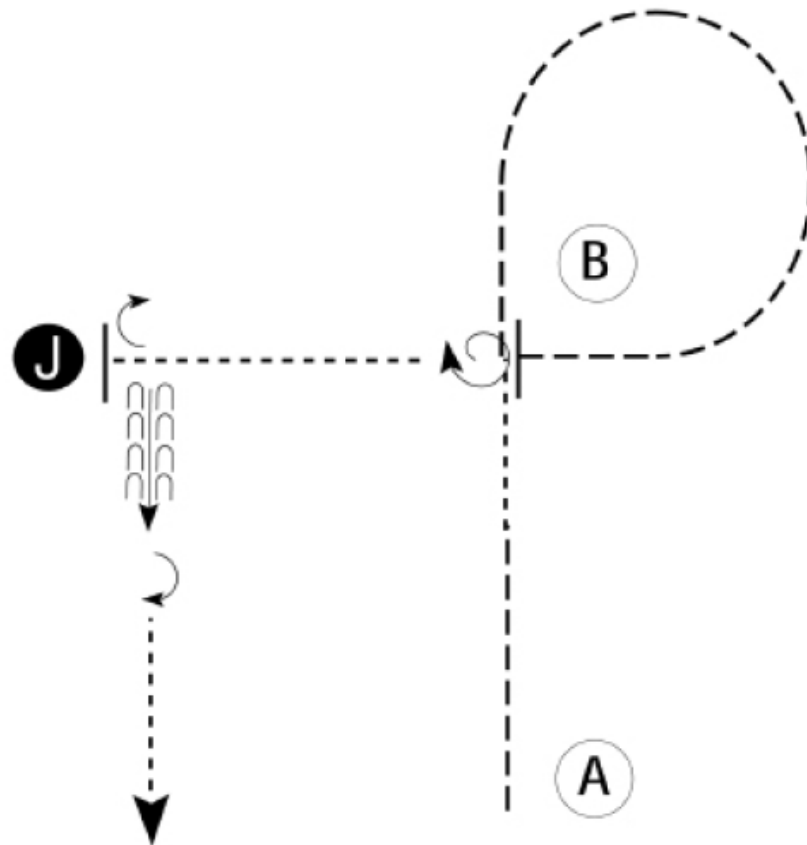

Be ready at A

1. Trot halfway to B.
2. Walk two horse lengths.
3. Trot to and around B as shown.
4. Trot past B and stop. Perform a 360 degree turn.
5. Walk to judge and set up for inspection.
6. When dismissed, perform a 90 degree turn and back approximately 2 horse lengths.
7. Perform a 180 degree turn and walk straight away.

## Showmanship at Halter

Q – LK 2/1 A/B

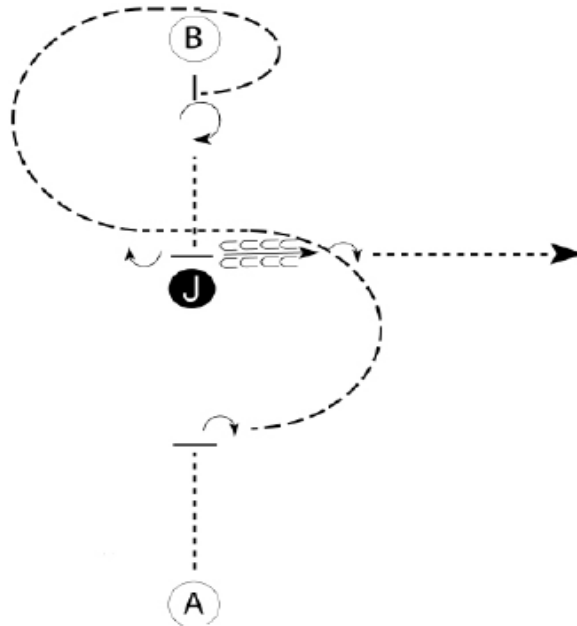

Be ready with your horse's tail at A.

1. Walk halfway to Judge.
2. Stop and perform a 1/4 turn.
3. Trot half circle. Break to a walk before Judge and walk at least two horse lengths past Judge.
4. Trot a half circle to and around B as shown.
5. Stop and perform a 3/4 turn and walk to Judge.
6. Stop and set up for inspection.
7. When dismissed, perform a 1/4 turn.
8. Back approximately one horse length.
9. Perform a 1/2 turn and walk straight away to exit.

# LK 1/2 TH junior

|   |                    |         |
|---|--------------------|---------|
|  | Q LK 2/1 JUN TRAIL |         |
|   | #3                 | 01/2018 |

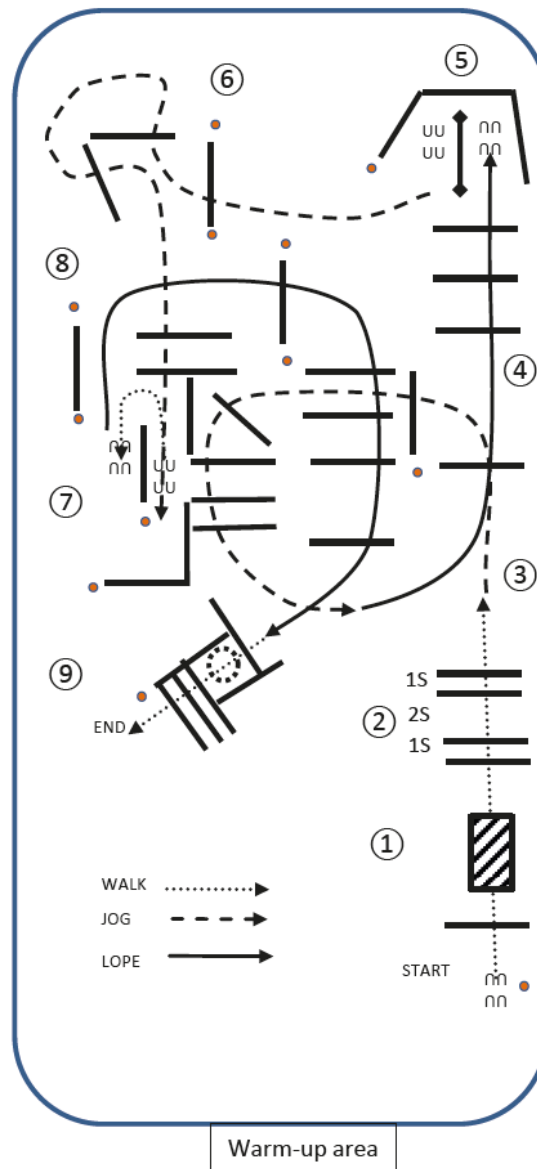

- 1 WALK OVER POLE- BRIDGE
- 2 WALK OVERS
- 3 JOG OVERS
- 4 LL LOPE OVERS
- 5 LL LOPE TO GATE -STOP- LH OPEN GATE  
WALK THRU CLOSE -JOG OUT
- 6 JOG OVERS
- 7 JOG INTO CHUTE STOP **BACK -UP**  
U INTO CHUTE RL LOPE OUT
- 8 RL LOPE OVERS
- 9 BREAK TO A WALK DO NOT STOP - WALK IN BOX  
360 TURN EITHER WAY-WALK OVERS  
END OF PATTERN

# LK 1/2 A TH senior; LK 1/2 B TH

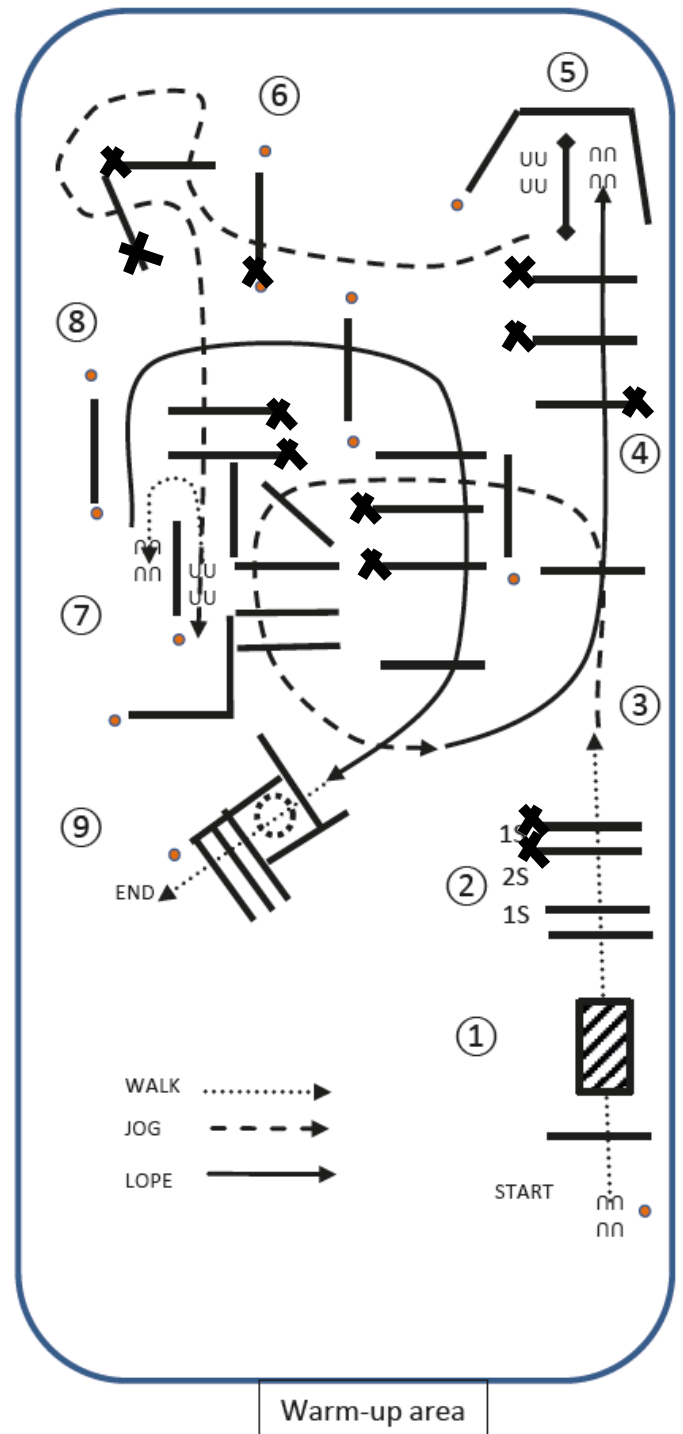

1 WALK OVER POLE- BRIDGE

2 WALK OVERS

3 JOG OVERS

4 LL LOPE OVERS

5 LL LOPE TO GATE -STOP- LH OPEN GATE

WALK THRU CLOSE -JOG OUT

6 JOG OVERS

7 JOG INTO CHUTE STOP **BACK -UP**

U INTO CHUTE RL LOPE OUT

8 RL LOPE OVERS

9 BREAK TO A WALK DO NOT STOP - WALK IN BOX

360 TURN EITHER WAY-WALK OVERS

END OF PATTERN

# LK 3 A/B TH

|   |                   |         |
|---|-------------------|---------|
|  | <b>LK 3 TRAIL</b> |         |
|   | <b>#5</b>         | 01/2018 |

- 1 BRIDGE
- 2 WALK OVERS-360 EITHER WAY-WALK OVER
- 3 JOG OVERS
- 4 LL LOPE OVERS
- 5 LL LOPE TO GATE-STOP-LH OPEN GATE WALK THRU CLOSE-JOG OUT
- 6 JOG OVERS
- 7 JOG INTO CHUTE STOP-BACK L INTO CHUTE RL LOPE OUT
- 8 RL LOPE OVERS
- 9 BREAK TO A WALK OR STOP-WALK IN BOX WALK OVERS
- END OF PATTERN

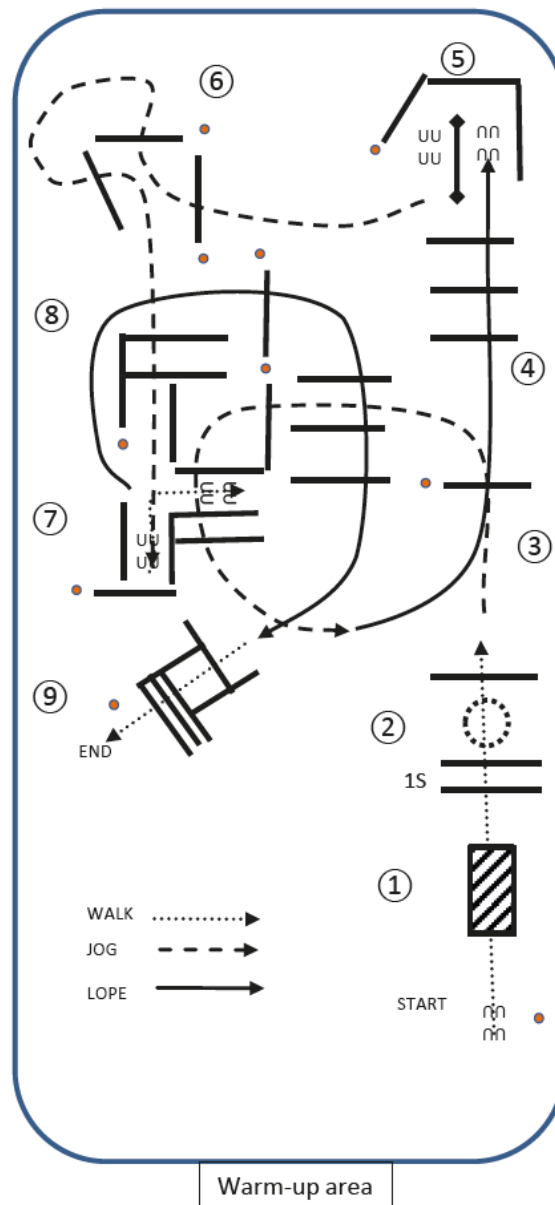

ERSTE WESTERNREITER UNION DEUTSCHLAND e.V. & ANN DENNIS®

## Q-LK 1/2 TH junior



Qualifikationspattern TH 2017 #4: LK 1/2 jun.  
 (Empfohlen für Hallen oder Plätze 20x40m)

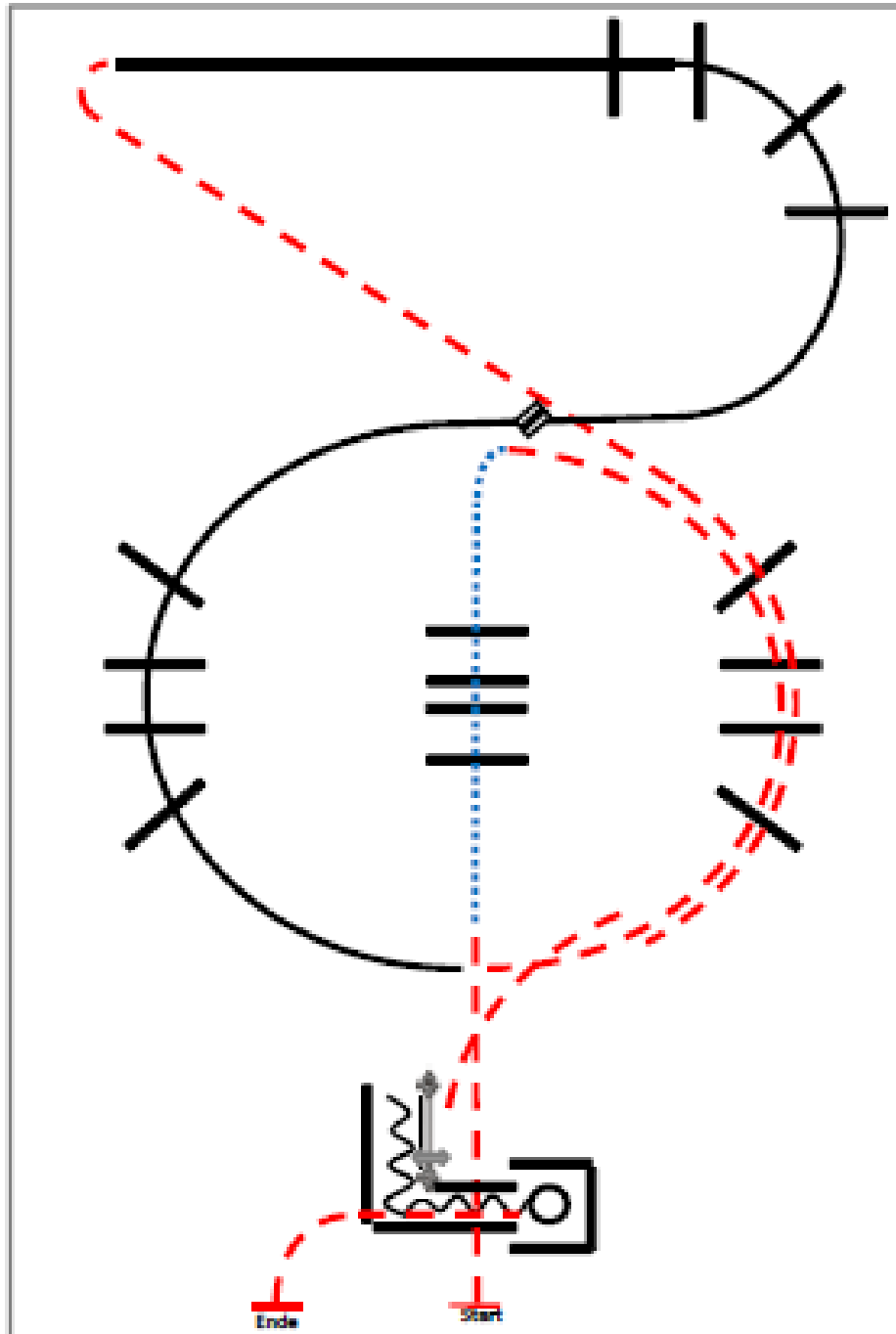

- 1) Jog over.
- 2) Walk over.
- 3) Jog over.
- 4) Lope over, lead change.
- 5) Lope over.
- 6) Jog over.
- 7) Ropegras with pole.
- 8) Back up.
- 9) Box 360 (r.o.l.), jog out, stop.

|   |                              |
|---|------------------------------|
|  | Back                         |
|  | Lope                         |
|  | Jog                          |
|  | Walk                         |
|  | Lead change<br>flying/simple |

Q-LK 1/2 A TH senior; Q-LK 1/2 B TH

Qualifikationspattern TH 2017 #3: LK 1/2 A/B sen.  
(Empfohlen für Hallen oder Plätze 20x40m)

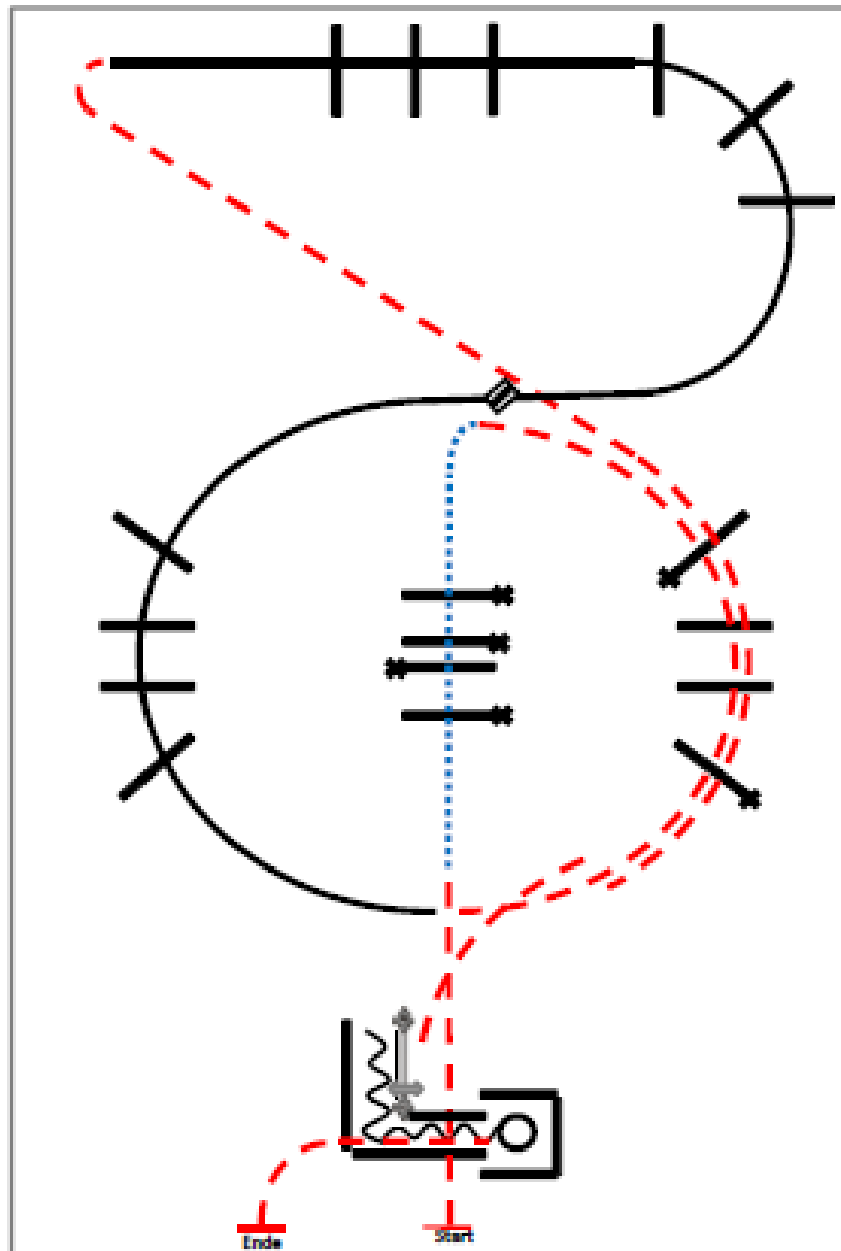

- 1) Jog over.
- 2) Walk over.
- 3) Jog over.
- 4) Lope over, lead change.
- 5) Lope over.
- 6) Jog over.
- 7) Ropegate with pole.
- 8) Back up.
- 9) Box 360 (r.u.l.), jog out, stop.

|  |                |
|--|----------------|
|  | Back           |
|  | Lope           |
|  | Jog            |
|  | Walk           |
|  | Lead change    |
|  | flaying/simple |

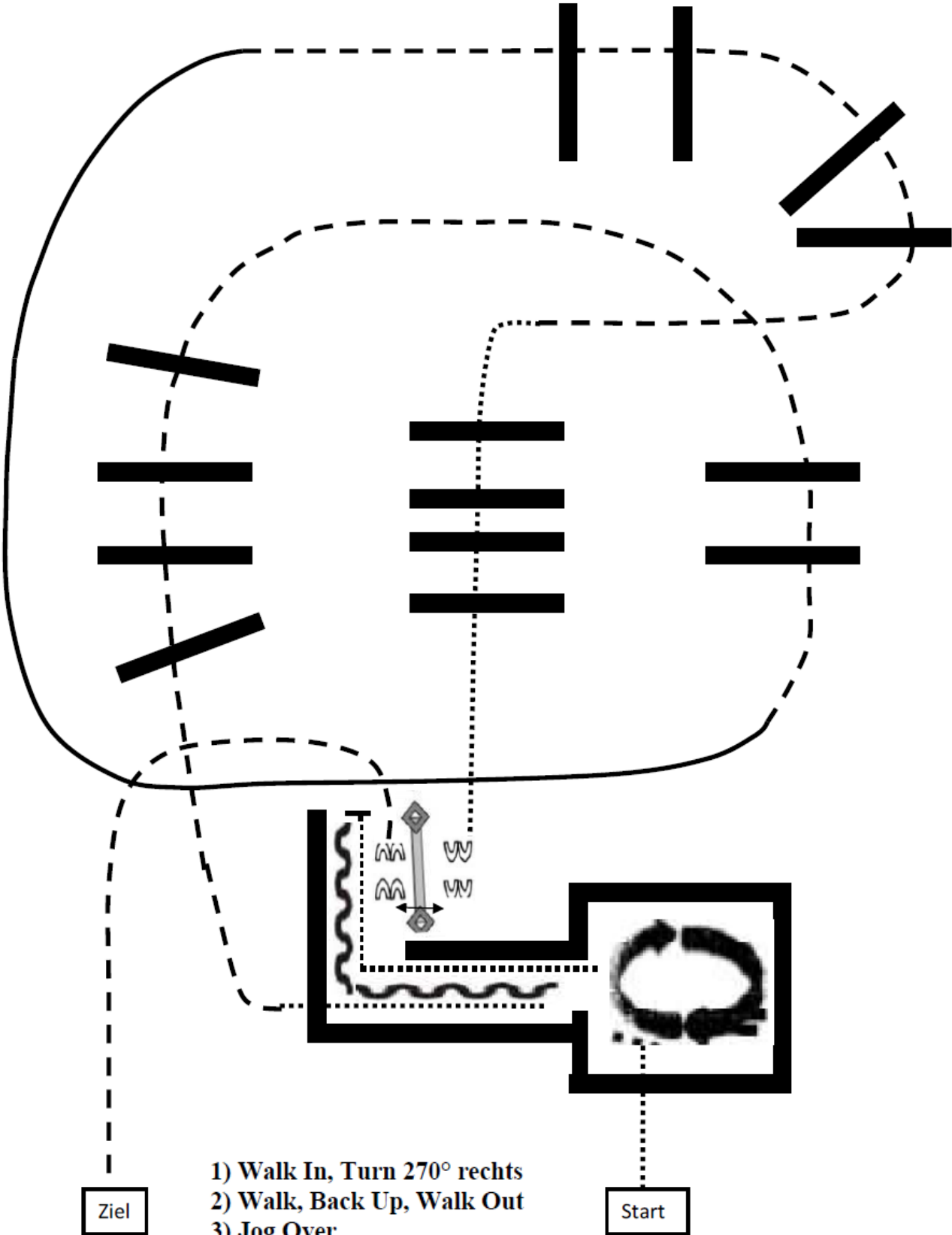

- 1) Walk In, Turn 270° rechts
- 2) Walk, Back Up, Walk Out
- 3) Jog Over
- 4) Lope RL
- 5) Jog Over
- 6) Walk Over
- 7) Tor

LK 4 A/B TH

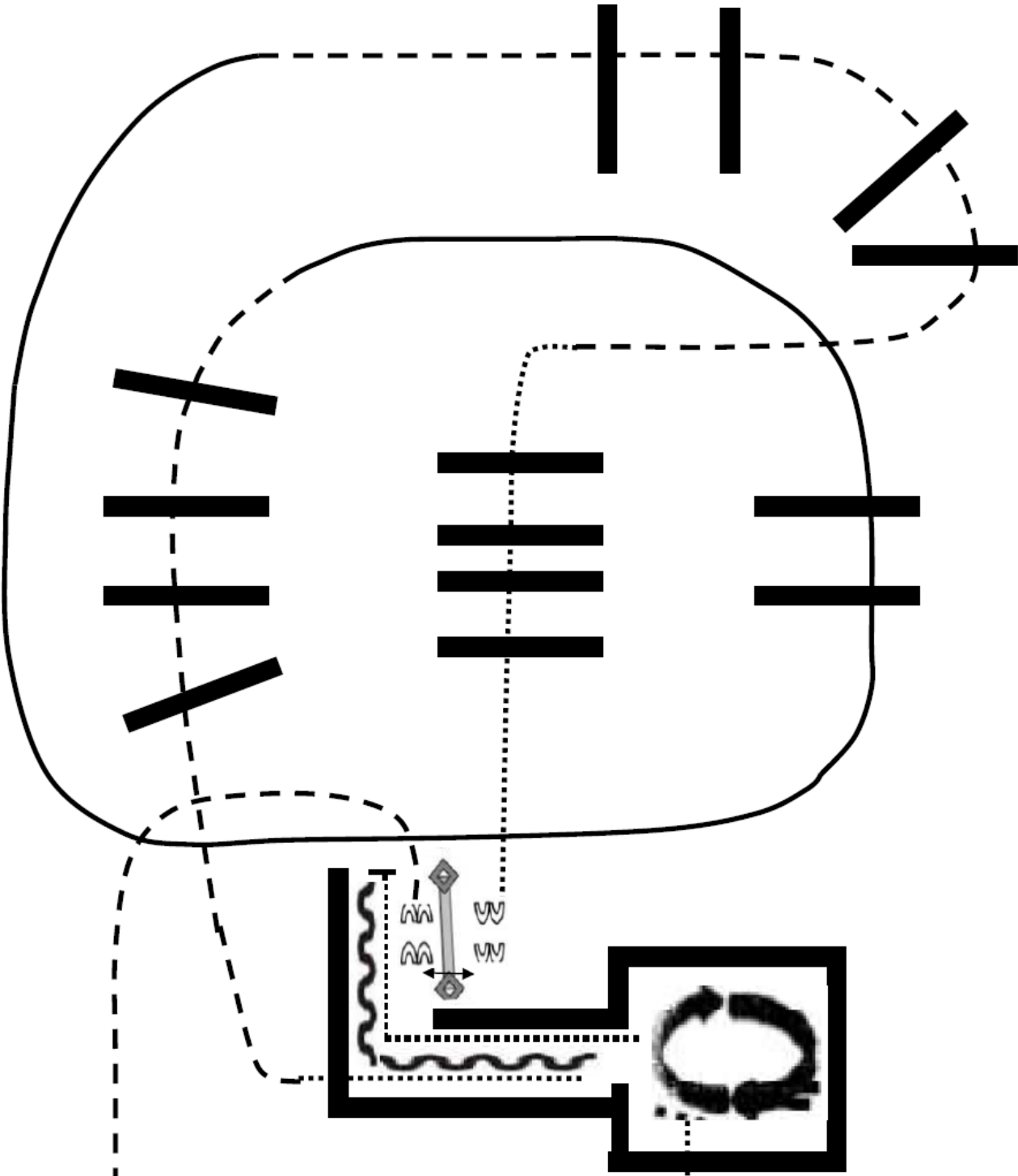

Ziel

- 1) Walk In, Turn 270° rechts
- 2) Walk, Back Up, Walk Out
- 3) Jog Over
- 4) Lope Over
- 5) Jog Over
- 6) Walk Over
- 7) Tor

Start

WT TH

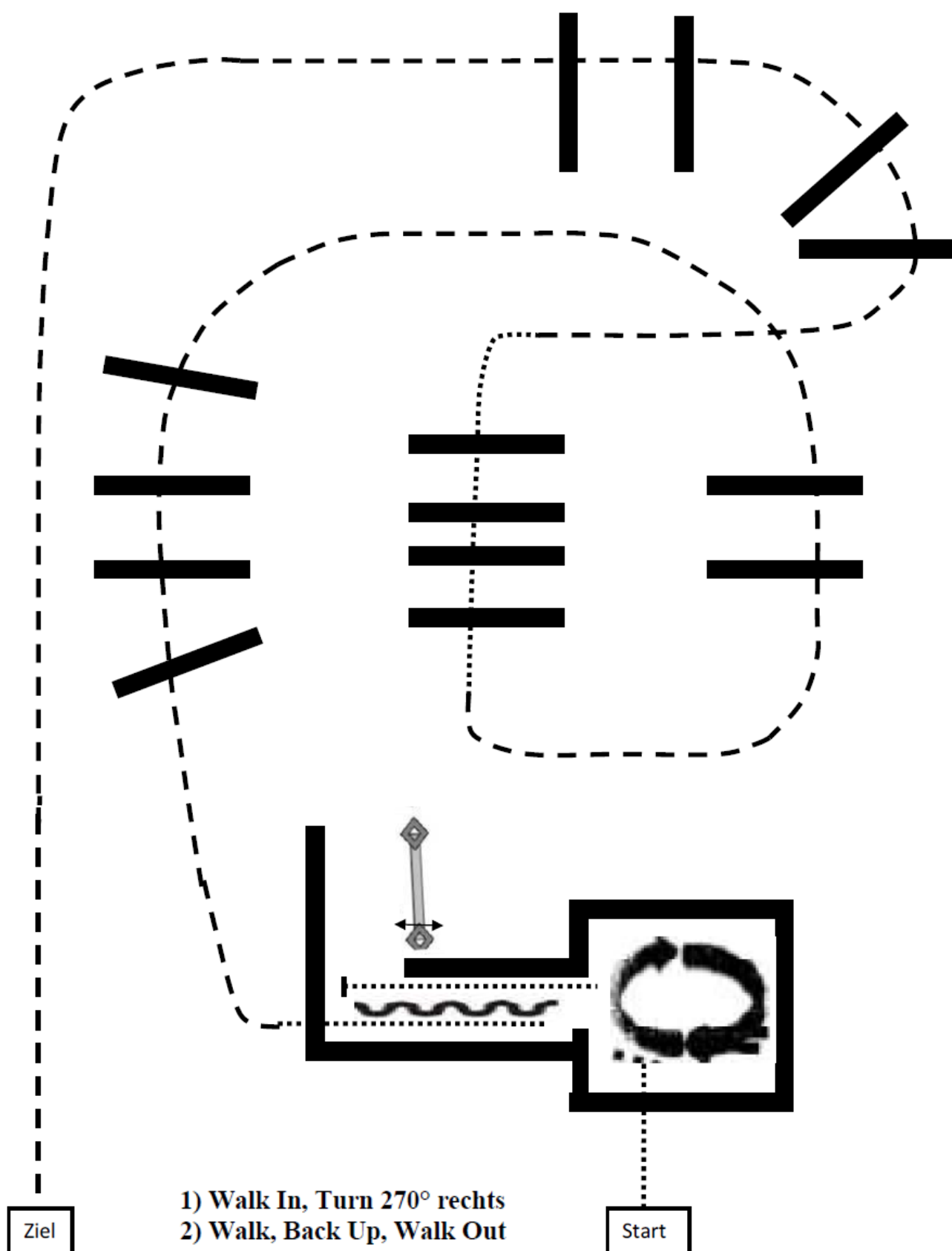

LK 1/2 H&D Trail

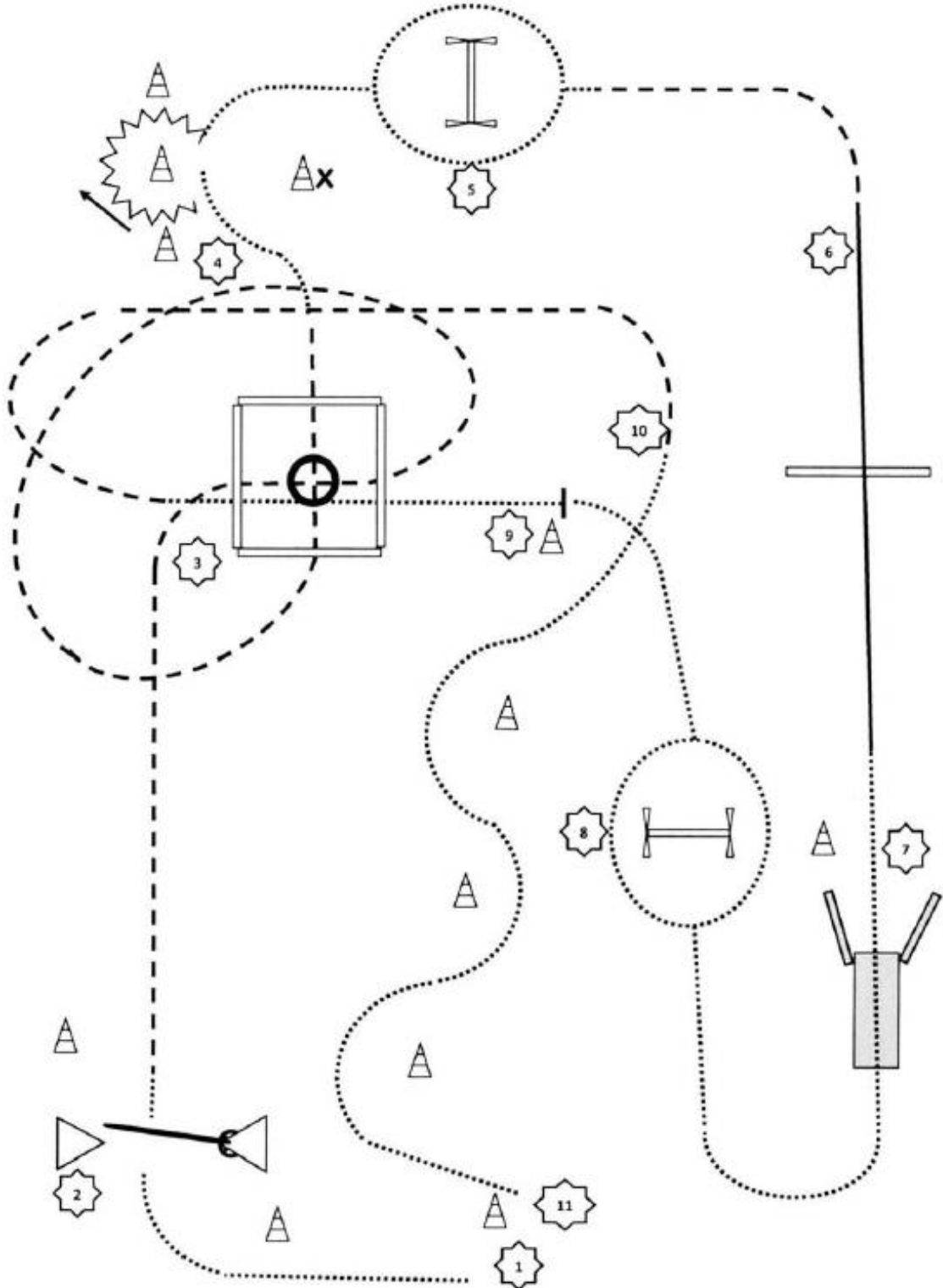

|    | Pferd & Reiter   | Hund   |
|----|--|--|
| 1  | An Pylone anhalten.<br>Walk zu 2.  | Hund ableinen.<br>Hund bei Fuß.  |
| 2  | An Pylone halten.<br>Tor beliebig öffnen, durchreiten,<br>weit öffnen. Tor schließen.<br>Walk, Jog zu 3. | Hund an Pylone ablegen.<br>Hund durch das Tor abrufen,<br>zur Pylone schicken, ablegen.<br>Hund bei Fuß. |
| 3  | Jog over.<br>Walk zu 4.  | Hund bei Fuß durch Box.<br>Hund bei Fuß.   |
| 4  | Back up.<br>Walk zu 5.   | Hund an Pylone mit dem X ablegen.<br>Hund bei Fuß.   |
| 5  | Walk li. oder re. am Sprung vorbei .<br>Jog zu 6.  | Hund springt über den Sprung.<br>Hund bei Fuß.   |
| 6  | Lope over 1 Stange.<br>Walk zu 7.  | Hund bei Fuß.<br>Hund bei Fuß.   |
| 7  | Walk über die Brücke.<br>Walk zu 8.  | Hund an Pylone ablegen.<br>Hund über die Brücke abrufen.<br>Hund bei Fuß.                                |
| 8  | Walk li. oder re. am Sprung vorbei .<br>Walk zu 9.   | Hund springt über den Sprung.<br>Hund bei Fuß.   |
| 9  | An Pylone anhalten.<br>Walk in Box, 360° Drehung. Walk out.<br>Jog zu 10.                                | Hund bei Pylone ablegen.<br>Hund durch die Box abrufen.<br>Hund bei Fuß.                                 |
| 10 | Walk Slalom.<br>Walk zu 11.  | Hund bei Fuß.<br>Hund bei Fuß.   |
| 11 | Anhalten, absteigen.   | Hund anleinen.   |

**Erklärung :**

Sprung sollte 20 cm bis 40 cm hoch sein  
( erhöhte Stange, Cavaletti, o.ä.).

Q-LK 1/2 H&D Trail

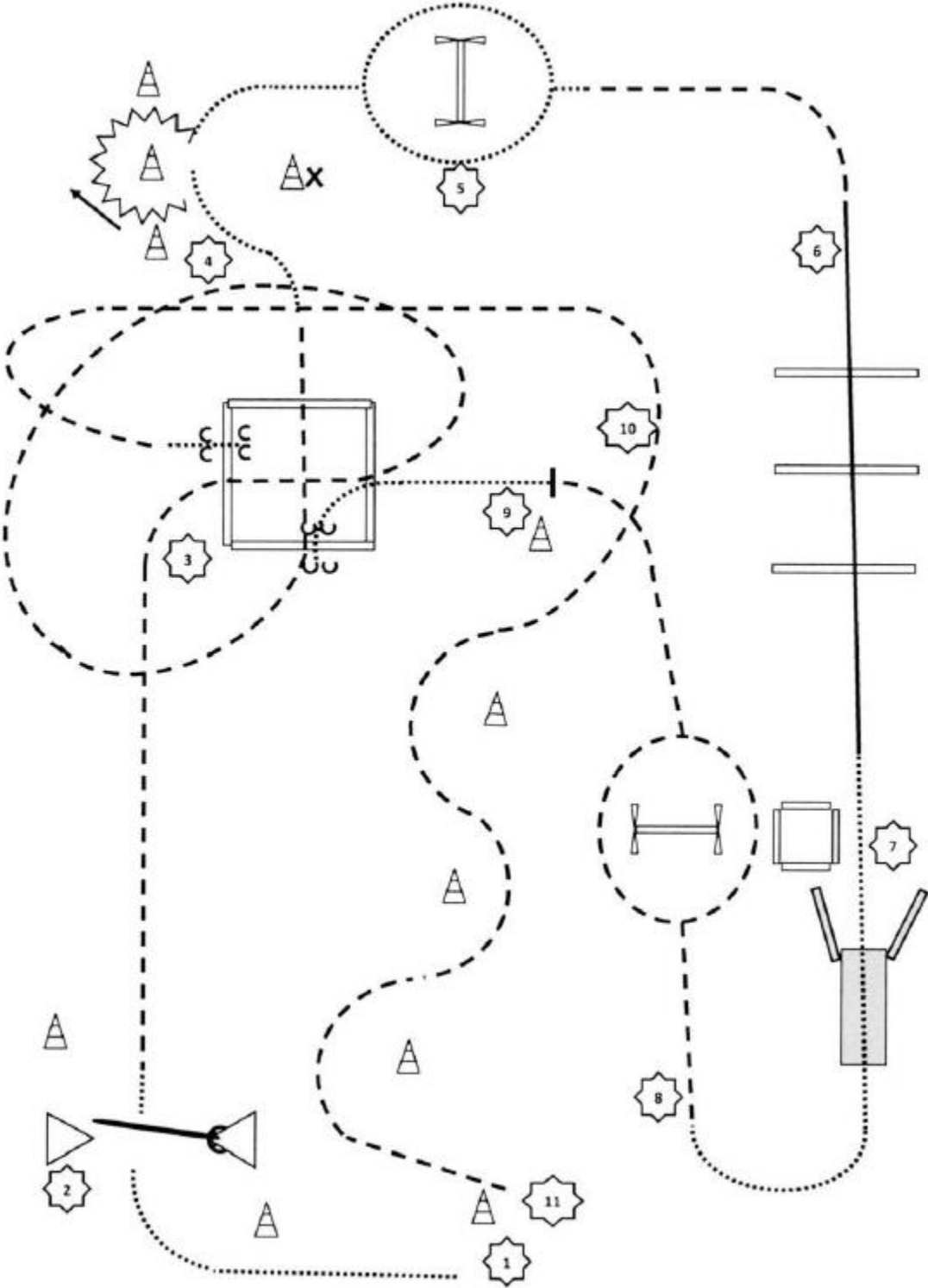



|    | Pferd & Reiter   | Hund   |
|----|--|--|
| 1  | An Pylone anhalten,<br>Walk zu 2.  | Hund ableinen.<br>Hund bei Fuß.  |
| 2  | Tor rückwärts öffnen,<br>Tor schließen.<br>Walk . Jog zu 3.                | Hund an Pylone ablegen.<br>Hund durch das Tor abrufen,<br>zur Pylone schicken, ablegen.<br>Hund bei Fuß. |
| 3  | Jog over.<br>Walk zu 4.  | Hund bei Fuß durch Box.<br>Hund bei Fuß.   |
| 4  | Back up.<br>Walk zu 5.   | Hund an Pylone mit dem X ablegen.<br>,<br>Hund bei Fuß.  |
| 5  | Walk li. oder re. am Sprung vorbei .<br>Jog zu 6.                          | Hund springt,<br>Hund bei Fuß.   |
| 6  | Lope over 3 Stangen.<br>Walk zu 7.   | Hund bei Fuß.<br>Hund bei Fuß.   |
| 7  | Walk über die Brücke.<br>Walk zu 8.  | Hund in Box ablegen.<br>Hund über die Brücke abrufen.<br>Hund bei Fuß.                                   |
| 8  | Jog li. oder re. am Sprung vorbei .<br>Jog zu 9.                           | Hund springt über den Sprung.<br>Hund bei Fuß.   |
| 9  | An Pylone anhalten.<br>Walk over, Sidepass rechts. Walk out.<br>Jog zu 10. | Hund bei Pylone ablegen.<br>Hund durch die Box abrufen.<br>Hund bei Fuß.                                 |
| 10 | Jog Slalom.<br>Jog zu 11.  | Hund bei Fuß.<br>Hund bei Fuß.   |
| 11 | Anhalten, absteigen.   | Hund anleinen.   |

**Erklärung:**

Sprung sollte 20 cm bis 40 cm hoch sein  
( erhöhte Stange, Cavaletti, o.ä.).

## Teilnehmerliste

|    | <b>Reiter</b>        | <b>Klasse</b> | <b>Pferd</b>          | <b>Geschl.</b> | <b>LV</b> | <b>Geb.</b> |
|----|----------------------|---------------|-----------------------|----------------|-----------|-------------|
| 1  | Leutner, Lisa        | LK 2A         | HC Just Good Wisely   | Wallach        | B/BRA QH  | 2014        |
| 2  | Gilsbach, Kerstin    | LK 3A         | LDR Docs Moon Lena    | Hengst         | SA/AN PH  | 2005        |
| 3  | Gilsbach, Kerstin    | LK 3A         | LDR Twenty One Guns   | Stute          | SA/AN PH  | 2012        |
| 4  | Koppenhagen, Nadin   | LK 3A         | Mr. Bean              | Wallach        | THÜR QH   | 2010        |
| 5  | Höke, Ivonne         | LK 2A         | TD Miss Smooth King   | Stute          | SACHS QH  | 2007        |
| 6  | Förster, Kerstin     | LK 2A         | Apollo                | Wallach        | SACHS Hal | 1995        |
| 7  | Förster, Kerstin     | LK 2A         | Jaecob Reburg         | Wallach        | SACHS PH  | 2002        |
| 8  | Zschaler, Lothar     | LK 2A         | Apollo                | Wallach        | SACHS Hal | 1995        |
| 9  | Winter, Herbert      | LK 1A         | Bueno Smokin Curtis   | Wallach        | SACHS QH  | 2011        |
| 10 | Faßbinder, Franziska | LK 3A         | A Real Chic           | Wallach        | SACHS QH  | 2002        |
| 11 | Leutner, Heike       | LK 2A         | HC Just Good Wisely   | Wallach        | B/BRA QH  | 2014        |
| 12 | Quaas, Frank         | LK 4A         | Joe Alberta           | Wallach        | SACHS QH  | 2006        |
| 13 | Unger, Katrin        | LK 1A         | Rascal Lil Chic       | Wallach        | THÜR QH   | 2004        |
| 14 | Wolter, Maria        | LK 2A         | Spooks Royal Sunshine | Wallach        | B/BRA PH  | 2014        |
| 15 | Roch, Melanie        | LK 1A         | DK Dancing Boys Joy   | Stute          | THÜR PH   | 2004        |
| 16 | Roch, Lucas          | LK 5B         | DK Dancing Boys Joy   | Stute          | PH        | 2004        |
| 17 | Lukjanowicz, Julia   | LK 5B         | Dunnit Quincy         | Stute          | PH        | 2004        |
| 18 | Lukjanowicz, Julia   | LK 5B         | Blue Eyed Starlight   | Stute          | PT        | 2010        |
| 19 | Szybko, Kamila       | LK 5A         | Blue Eyed Starlight   | Stute          | PT        | 2010        |
| 20 | Szybko, Kamila       | LK 5A         | Dunnit Quincy         | Stute          | PH        | 2004        |
| 21 | Borysiuk, Oliwia     | LK 5B         | Dunnit Quincy         | Stute          | PH        | 2004        |
| 22 | Tomkiewicz, Julia    | LK 5B         | Dunnit Quincy         | Stute          | PH        | 2004        |
| 23 | Rusak, Karolina      | LK 2A         | Dunnit Quincy         | Stute          | SACHS PH  | 2004        |
| 24 | Heinemann, Frank     | LK 1A         | Wonders Peggy Sue     | Stute          | THÜR QH   | 2011        |
| 25 | Heinemann, Frank     | LK 1A         | Reds Benito Pine      | Wallach        | THÜR QH   | 2013        |
| 26 | Panius, Jette        | LK 4B         | Sunday Cool           | Wallach        | SACHS QH  | 1999        |
| 27 | Lehmann, Heike       | LK 2A         | Chex Cherokee         | Wallach        | SACHS PH  | 2012        |
| 28 | Niederschuh, Sandra  | LK 2A         | Joy`s Red Rock        | Wallach        | THÜR WGP  | 2006        |
| 29 | Klopfleisch, Susann  | LK 2A         | Mr. Rio Dee Bar       | Wallach        | THÜR QH   | 2001        |
| 30 | Grimm, Emira         | LK 4A         | SR Painted By Sox     | Wallach        | SACHS WGP | 2009        |
| 31 | Tobler, Tell         | LK 1B         | Coeur Lee Boon MM     | Wallach        | HH/SH QH  | 2012        |
| 32 | Tobler, Tell         | LK 1B         | VT Hollywood Rainbow  | Wallach        | HH/SH QH  | 2004        |
| 33 | Hellwig, Mia Helene  | LK 5B         | Peppys Golden Olena   | Stute          | SACHS QH  | 2004        |
| 34 | Günther, Anke        | LK 4A         | Codys Little Wimpy    | Wallach        | SACHS QH  | 2012        |
| 35 | Steidl, Maria        | LK 1A         | Barneys Miss Royal    | Stute          | SACHS PH  | 2003        |
| 36 | Möritz, Lilian       | LK 3B         | Tarzan                | Wallach        | SACHS WGP | 2005        |
| 37 | Möritz, Viktoria     | LK 5B         | Tarzan                | Wallach        | WGP       | 2005        |
| 38 | Möritz, Nicole       | LK 3A         | Tarzan                | Wallach        | SACHS WGP | 2005        |
| 39 | Dietl, Dagmar        | LK 2A         | Sonitas Sunrise       | Wallach        | BAY QH    | 2007        |
| 40 | Scholz, Sarina       | LK 3B         | Sonitas Sunrise       | Wallach        | BAY QH    | 2007        |
| 41 | Dietl, Dagmar        | LK 2A         | Donna Lottchen        | Stute          | BAY QH    | 2009        |
| 42 | Scholz, Sarina       | LK 3B         | Donna Lottchen        | Stute          | BAY QH    | 2009        |
| 43 | Ziegler, Jessica     | LK 1A         | LDR Smoking Lil Step  | Hengst         | SA/AN QH  | 2014        |
| 44 | Samse, Anna-Alisa    | LK 1A         | Shot Girl             | Stute          | NS/H PH   | 2008        |
| 45 | Paetzold, Raquel     | LK 2A         | Shining All Stars     | Stute          | NS/H QH   | 2010        |
| 46 | Kirchner, Matthias   | LK 2A         | Junes Spinning Storm  | Wallach        | SACHS QH  | 1997        |
| 47 | Kirchner, Katrin     | LK 3A         | Junes Spinning Storm  | Wallach        | SACHS QH  | 1997        |
| 48 | Constantin, Cindy    | LK 2B         | Mitos Honeymoon       | Stute          | SACHS PH  | 2001        |
| 49 | Hummel, Christine    | LK 1A         | Cherokee Cool Rainman | Wallach        | BAY PH    | 2012        |
| 50 | Waber, Constance     | LK 1A         | Sparkling Tucker      | Wallach        | SACHS QH  | 2011        |
| 51 | Waber, Constance     | LK 1A         | Girly Gun             | Stute          | SACHS QH  | 2014        |
| 52 | Waber, Constance     | LK 1A         | Classic Western Art   | Wallach        | SACHS PH  | 2009        |
| 53 | Mattstädt, Lisa      | LK 3B         | Skips Big Hidalgo     | Wallach        | B/BRA QH  | 2006        |
| 54 | Platzbäcker, Sylvia  | LK 2A         | Smoky                 | Wallach        | B/BRA Hal | 1998        |
| 55 | Dechert, Bernd       | LK 3A         | BV Okie Chin Cha      | Wallach        | SACHS QH  | 2002        |
| 56 | Hesse, Anja          | LK 3A         | Jacs Little Wimpy     | Wallach        | THÜR QH   | 2014        |
| 57 | Hesse, Julius        | LK 2B         | Pars Leo Bug          | Hengst         | THÜR QH   | 2002        |
| 58 | Hesse, Heiko         | LK 1A         | Spark Spook           | Stute          | THÜR QH   | 2013        |
| 59 | Hesse, Heiko         | LK 1A         | Bet Hesa Fire         | Hengst         | THÜR QH   | 2013        |
| 60 | Finn, Anna           | LK 2A         | Mr. Rio Dee Bar       | Wallach        | THÜR QH   | 2001        |

|     |                         |       |                       |         |             |      |      |
|-----|-------------------------|-------|-----------------------|---------|-------------|------|------|
| 61  | Mohnert, Karolin        | LK 1A | Santos Lynx           | Wallach | SA/AN       | PH   | 2004 |
| 62  | Mohnert, Karolin        | LK 1A | BB Smart Player       | Wallach | SA/AN       | PH   | 2011 |
| 63  | Doerschel, Kristina     | LK 2A | BBC Sue High Britches | Stute   | B/BRA       | PH   | 2004 |
| 64  | Franke, Caroline        | LK 3B | Mr Skips Big Boy      | Wallach | B/BRA       | QH   | 2009 |
| 65  | Hoffmann, Giuliana      | LK 3B | Doubled Emphasis      | Wallach | SACHS       | PH   | 1993 |
| 66  | Ensfelder, Noemi-Lucie  | LK 1B | BMS Kurty Gun         | Wallach | SACHS       | QH   | 2014 |
| 67  | Willun, Sven            | LK 1A | Yakima                | Stute   | B/BRA       | WGP  | 2003 |
| 68  | Willun, Birgit          | LK 1A | CR                    | Stute   | B/BRA       | PH   | 2010 |
| 69  | Behrens, Annett         | LK 1A | Mr. Snow Dancer       | Wallach | THÜR        | QP   | 2012 |
| 70  | Behrens, Sara           | LK 1B | Mr. Snow Dancer       | Wallach | THÜR        | QP   | 2012 |
| 71  | Behrens, Sara           | LK 1B | Chunn Bars Cody       | Wallach | THÜR        | QH   | 1999 |
| 72  | Krause, Elsa            | LK 5B | Mr Hollywood Rocket   | Wallach |             | QH   | 2000 |
| 73  | Till, Maria Theresia    | LK 1A | Mr Hollywood Rocket   | Wallach | SACHS       | QH   | 2000 |
| 74  | Till, Maria Theresia    | LK 1A | Grays Superstar Girl  | Stute   | SACHS       | QH   | 2001 |
| 75  | Till, Maria Theresia    | LK 1A | Duallywood Andaure    | Wallach | SACHS       | QH   | 2003 |
| 76  | Binnewies, Simone       | LK 4A | Grays Superstar Girl  | Stute   | SACHS       | QH   | 2001 |
| 77  | Wendt, Stefanie         | LK 1A | An Angel For Charley  | Stute   | SACHS       | QH   | 2004 |
| 78  | Krehfeld, Lea Laetitia  | LK 2B | Mira                  | Stute   | SACHS       | Hal  | 2011 |
| 79  | Wermann, Leonie         | LK 4B | Little Pepper Spirit  | Wallach | SACHS       | QH   | 2011 |
| 80  | Wunderlich, Marlen      | LK 5B | Contre Coeur JP       | Wallach | SACHS       | QH   | 2010 |
| 81  | Rüchardt, Linda Marlen  | LK 4B | Menowin               | Wallach | THÜR        | DR   | 2010 |
| 82  | Müller, Britta          | LK 1A | Callmea Krymsunkutie  | Stute   | B/BRA       | QH   | 2009 |
| 83  | Michaelis, Jessica      | LK 2A | San Shorty Bar        | Wallach | B/BRA       | QH   | 2005 |
| 84  | Birke, Jennifer         | LK 1A | THR Tassilos Picasso  | Wallach | SACHS       | APP  | 2009 |
| 85  | Manthey, Nadin          | LK 1A | Joy Double Chex       | Stute   | B/BRA       | QH   | 2011 |
| 86  | Viola, Francesca        | LK 3A | Genuine Lil Snap      | Stute   | NS/H        | QH   | 2010 |
| 87  | Kunz, Anja              | LK 1A | Walla Walla Electric  | Wallach | B/BRA       | QH   | 2012 |
| 88  | Wendt, Stefanie         | LK 1A | Peppys Golden Olena   | Stute   | SACHS       | QH   | 2004 |
| 89  | Kopsch, Luisa           | LK 3A | Walla Walla Electric  | Wallach | B/BRA       | QH   | 2012 |
| 90  | Seitz, Uli              | LK 3A | Peppy San Litenin     | Wallach | B/BRA       | QH   | 2005 |
| 91  | Schefter, Kathleen      | LK 2A | Lightning             | Wallach | B/BRA       | PIN  | 2004 |
| 92  | Berend, Stefani         | LK 2A | Mr Jet Zisko          | Wallach | B/BRA       | PH   | 2013 |
| 93  | Donath, Sandra          | LK 1A | Sunny                 | Stute   | SACHS       | PIN  | 2004 |
| 94  | Keil, Laura             | LK 1B | Arabella              | Stute   | SACHS       | WGPo | 1998 |
| 95  | Roth, Isabel            | LK 1A | DD More Than A        | Wallach | SACHS       | PH   | 2011 |
| 96  | Roth, Maria             | LK 1A | Rising Star           | Wallach | SACHS       | WGP  | 2002 |
| 97  | Schmidt, Manuel         | LK 3A | Easys Power Uen       | Wallach | SACHS       | PH   | 1998 |
| 98  | Hohoff, Kristin         | LK 1A | Elans Red Nayana      | Stute   | B/BRA       | PH   | 2007 |
| 99  | Voß, Anna               | LK 1A | BH Shesplashmetonite  | Stute   | NS/H        | QH   | 2014 |
| 100 | Gärtner, Sarah          | LK 1A | Sparkling Tucker      | Wallach | SACHS       | QH   | 2011 |
| 101 | Mattheß, Justine        | LK 3B | MS Fairly Vision      | Stute   | THÜR        | APP  | 2007 |
| 102 | Schirrmeister, Annalena | LK 5B | Cool Man 41           | Wallach | SA/AN       |      | 2013 |
| 103 | Heym, Anne-Marie        | LK 4A | Cool Man 41           | Wallach | SACHS       |      | 2013 |
| 104 | Heym, Anne-Marie        | LK 4A | Ninjo                 | Wallach | SACHS       | WGPo | 2005 |
| 105 | Haase, Susanne          | LK 2A | Be My Moonlight       | Stute   | B/BRA       | QH   | 2010 |
| 106 | Piltz, Edzard           | LK 2A | Pecos Rooster         | Wallach | B/BRA       | QH   | 2010 |
| 107 | Schmidt, Nina           | LK 3B | Freckles Prince       | Wallach | SA/AN       | APP  | 2007 |
| 108 | Schmidt, Nina           | LK 3B | Carlo                 | Wallach | SA/AN       | PIN  | 2006 |
| 109 | Heyer, Helene           | LK 2B | Freckles Prince       | Wallach | SA/AN       | APP  | 2007 |
| 110 | Heyer, Hanna            | LK 2B | Carlo                 | Wallach | SA/AN       | PIN  | 2006 |
| 111 | Süllau, Laura           | LK 5B | Shot Girl             | Stute   |             | PH   | 2008 |
| 112 | Schumann, Laura         | LK 1A | Duallywood Andaure    | Wallach | SACHS       | QH   | 2003 |
| 113 | Bahn, Sandra            | LK 4A | BD Glory Lady         | Stute   | SACHS       | QH   | 2000 |
| 114 | Bahn, Sandra            | LK 4A | Ricky Rooster Taco    | Wallach | SACHS       | QH   | 2007 |
| 115 | Hagen, Zoe              | LK 3A | City Spook            | Stute   | B/BRA       | QH   | 2013 |
| 116 | Lesch, Lia              | LK 3B | Sam                   | Wallach | SACHS       | WGPo | 2002 |
| 117 | Müller, Louisa          | LK 1A | Zips Golden Rose      | Stute   | SACHS       | QH   | 1997 |
| 118 | Lindenblatt, Henrike    | LK 2A | Gunnerella Dun It     | Stute   | B/BRA       | QH   | 2014 |
| 119 | Künkel, Mara            | LK 2B | Smartys Pointed Poldi | Wallach | BAY         | PIN  | 2011 |
| 120 | Timm, Imke              | LK 3A | Play With Guns        | Stute   | B/BRA       | PH   | 2011 |
| 121 | Schütze, Ann-Kathrin    | LK 2B | AKS April Due         | Stute   | HB/NS, NS/H | QH   | 2011 |
| 122 | Schütze, Ann-Kathrin    | LK 2B | AKS Due Time Reward   | Stute   | HB/NS, NS/H | QH   | 2010 |

|     |                        |       |                         |         |              |      |      |
|-----|------------------------|-------|-------------------------|---------|--------------|------|------|
| 123 | Backer, Susanne        | LK 1A | My Chippy Major         | Wallach | BAY          | QH   | 2012 |
| 124 | Backer, Susanne        | LK 1A | Revolutionary Lexus     | Wallach | BAY          | QH   | 2005 |
| 125 | Rautenberg, Maxine     | LK 1B | Agent Snowflake         | Wallach | B/BRA        | APP  | 2002 |
| 126 | Rautenberg, Myra       | LK 1B | Smart Matt O Lena       | Wallach | B/BRA        | QH   | 2002 |
| 127 | Gerber, Katrin         | LK 3A | Bacas Dancing Annie     | Stute   | SACHS        | QH   | 2011 |
| 128 | Klauditz, Anja         | LK 2A | Kims Next Generation    | Hengst  | BAY          | QH   | 2011 |
| 129 | Bong, Manuela          | LK 2A | IHR Ruby Cash           | Stute   | B/BRA        | WGP  | 2007 |
| 130 | Wolter, Andrea         | LK 2A | Skips Dear Chief Joseph | Wallach | B/BRA        | WGP  | 2008 |
| 131 | Golding, André         | LK 4A | Misscolonels Mystery    | Stute   | SACHS        | PH   | 2008 |
| 132 | Ullrich, Maret         | LK 2A | CL Shasta Skip Zip      | Stute   | SACHS        | QH   | 2012 |
| 133 | Drößler, Jana          | LK 1B | Stubs-Pep-Olena         | Stute   | NS/H         | QH   | 2002 |
| 134 | Zickert, Ranita        | LK 3A | Chesmu Jack of King     | Hengst  | SACHS        | QH   | 2010 |
| 135 | Ottlinger, Ina         | LK 1A | Duggy Dakota            | Wallach | SACHS        | WGP  | 2002 |
| 136 | Reichel, Peggy         | LK 3A | Jessie Polly Ann        | Stute   | SACHS        | PH   | 2001 |
| 137 | Laue, Erik             | LK 1A | Flash My Guns           | Wallach | SACHS        | QH   | 2013 |
| 138 | Wolf, Victoria         | LK 3A | Santana Q               | Wallach | SACHS        | IC   | 2007 |
| 139 | Wolf, Victoria         | LK 3A | Flash My Guns           | Wallach | SACHS        | QH   | 2013 |
| 140 | Wolf, Victoria         | LK 3A | Girly Gun               | Stute   | SACHS        | QH   | 2014 |
| 141 | Hähnlein, Cindy        | LK 3A | Zippos Shining Boy      | Hengst  | SACHS        | QH   | 2013 |
| 142 | Dietrich, Livgreet     | LK 3B | SH Zips Sweetpassion    | Stute   | SACHS        | QH   | 2007 |
| 143 | Georgi, Claus          | LK 1A | SH Zips Sweetpassion    | Stute   | SA/AN, SACHS | QH   | 2007 |
| 144 | Georgi, Lisa-Marie     | LK 1A | Zippos Shining Boy      | Hengst  | SA/AN, SACHS | QH   | 2013 |
| 145 | Georgi, Lisa-Marie     | LK 1A | Snap Dragon Junior      | Wallach | SA/AN, SACHS | QH   | 2004 |
| 146 | Bendig-Krebs, Monika   | LK 3A | Only A Gentleman        | Wallach | B/BRA        | QH   | 2010 |
| 147 | Kloust, Jolene         | LK 2B | IHR Rocky Road Cash     | Wallach | SACHS        | APP  | 2011 |
| 148 | Kloust, Jolene         | LK 2B | Little John             | Wallach | SACHS        | WGPo | 2009 |
| 149 | Petrov, Alida          | LK 2A | Smart Royal Player      | Wallach | SACHS        | QH   | 2000 |
| 150 | Waida, Freya           | LK 4B | Whoyacallinwimpy        | Wallach | B/BRA        | QH   | 2005 |
| 151 | Libuschewski, Tobias   | LK 2B | Charleys Bueno Chex     | Wallach | SACHS        | QH   | 2013 |
| 152 | Libuschewski, Kerstin  | LK 3A | SR Painted By Sox       | Wallach | SACHS        | WGP  | 2009 |
| 153 | Petrov, Joy            | LK 5B | Smart Royal Player      | Wallach |              | QH   | 2000 |
| 154 | Saure, Ceara           | LK 3B | Squanic                 | Wallach | B/BRA        | QH   | 2009 |
| 155 | Antal, Anjulie         | LK 5B | Banny                   | Stute   | SACHS        | WGPo | 2011 |
| 156 | Antal, Lillien         | LK 5B | Britta                  | Stute   | SACHS        | Shet | 2006 |
| 157 | Antal, Yvonne          | LK 1A | Peppys Golden Olena     | Stute   | SACHS        | QH   | 2004 |
| 158 | Antal, Yvonne          | LK 1A | An Angel For Charley    | Stute   | SACHS        | QH   | 2004 |
| 159 | Lindner, Uwe           | LK 1A | Mr Pappa Chic           | Wallach | SACHS        | QH   | 2001 |
| 160 | Lindner, Martina       | LK 3A | BB Anymore              | Stute   | SACHS        | PH   | 2002 |
| 161 | Roeke, Lisa-Marie      | LK 4B | Monty 582               | Wallach | B/BRA        | LW   | 2011 |
| 162 | Kunkel, Anna Magdalena | LK 5B | HC Follow Me            | Wallach | SACHS        | QH   | 2009 |
| 163 | Kunkel, Kirsten        | LK 2A | HC Follow Me            | Wallach | SACHS        | QH   | 2009 |
| 164 | Weise, Erik            | LK 2A | Ferrari Player          | Hengst  | SACHS        | QH   | 2011 |
| 165 | Weise, Erik            | LK 2A | Ferrariking Sunshine    | Stute   | SACHS        | QH   | 2011 |
| 166 | Weise, Erik            | LK 2A | Invisible Spotted Perce | Hengst  | SACHS        | APP  | 2009 |
| 167 | Großer, Amely          | LK 3B | Ferrariking Sunshine    | Stute   | SACHS        | QH   | 2011 |
| 168 | Grosser, Bianca        | LK 2A | Ferrariking Sunshine    | Stute   | SACHS        | QH   | 2011 |
| 169 | Großer, Nancy          | LK 1A | Ferrari Player          | Hengst  | SACHS        | QH   | 2011 |
| 170 | Großer, Nancy          | LK 1A | Invisible Spotted Perce | Hengst  | SACHS        | APP  | 2009 |
| 171 | Patzelt, Peter         | LK 3A | Shadow                  | Stute   | SACHS        | PIN  | 2011 |
| 172 | Faßbinder, Michael     | LK 4A | A Real Chic             | Wallach | SACHS        | QH   | 2002 |
| 173 | Löbel, Eva             | LK 1A | Smart Charls of Tivio   | Wallach | SACHS        | PH   | 2002 |
| 174 | Hillmann, Laura        | LK 5B | A Real Chic             | Wallach |              | QH   | 2002 |
| 175 | Wetzig, Lucy           | LK 3B | CP Seventyfive          | Wallach | SACHS        | PH   | 2006 |
| 176 | Schöne, Evelyn         | LK 2A | Tanquery Dandy          | Wallach | SACHS        | QH   | 2004 |
| 177 | Herder, Hendrikje      | LK 4A | CH Smokin Little Lucy   | Stute   | B/BRA        | PH   | 2013 |
| 178 | Dunkel, Marie          | LK 2B | Notice Any Bueno        | Stute   | B/BRA        | QH   | 2008 |
| 179 | Schwark, Carmen        | LK 3A | Smart Royal Player      | Wallach | SACHS        | QH   | 2000 |
| 180 | Buruncz, Ava Lexa      | LK 4B | PR He Is My Desert Son  | Wallach | SACHS        | PoA  | 2009 |
| 181 | Helm, Ebigel           | LK 4B | Cheyenne                | Wallach | SACHS        | WGP  | 1999 |
| 182 | Link, Inola            | LK 2B | Cheyenne                | Wallach | SACHS        | WGP  | 1999 |
| 183 | Link, Lilian           | LK 3B | PR He Is My Desert Son  | Wallach | SACHS        | PoA  | 2009 |
| 184 | Hartmann, Franziska    | LK 3A | Dun Its John Lennon     | Wallach | SACHS        | QH   | 2010 |

|     |                          |       |                       |         |            |      |      |
|-----|--------------------------|-------|-----------------------|---------|------------|------|------|
| 185 | Heinrich, Lisa-Maria     | LK 3B | Dun Its John Lennon   | Wallach | SACHS      | QH   | 2010 |
| 186 | Stein, Anna-Sophie       | LK 3A | Classic Western Art   | Wallach | SACHS      | PH   | 2009 |
| 187 | Kasten, Claudia          | LK 3A | DD Just Nastys Cat    | Stute   | SACHS      | QH   | 2012 |
| 188 | Jantzen, Ilka            | LK 1A | Twisted Smart Peppy   | Stute   | B/BRA      | QH   | 2002 |
| 189 | Hentschel, Arleen Sharon | LK 3A | Chips Lark Speciale   | Wallach | B/BRA      | QH   | 2012 |
| 190 | Hentschel, Ines          | LK 1A | Nics Peppy Blues      | Wallach | B/BRA      | QH   | 2010 |
| 191 | Hentschel, Ines          | LK 1A | Chips Lark Speciale   | Wallach | B/BRA      | QH   | 2012 |
| 192 | Westphal, Marie          | LK 1A | Chip Lil Chocolate    | Wallach | SACHS      | QH   | 2010 |
| 193 | Vogel, Roland            | LK 3A | GMG Magic Promise     | Hengst  | SACHS      | PH   | 2010 |
| 194 | Rößler, Anica            | LK 5B | Chica 109             | Stute   |            | AN   | 2007 |
| 195 | Mader, Sandra            | LK 3A | Tamino                | Wallach | SACHS      | DR   | 2001 |
| 196 | Bernstein, Pia           | LK 2B | Jaemy Bar Fox         | Stute   | B/BRA      | QH   | 2009 |
| 197 | Böhm, Johanna            | LK 5B | FRS Tibullo           | Wallach |            | QH   | 2003 |
| 198 | Kulke, Mirko             | LK 4A | Serenades Blakcmagic  | Wallach | SA/AN      | QH   | 2010 |
| 199 | Pisch, Caroline          | LK 1A | Vested In Blue Ivy    | Stute   | B/BRA, APP |      | 2010 |
| 200 | Rentsch, Ute             | LK 3A | Kamerun's Gaia        | Stute   | SACHS      | DR   | 2002 |
| 201 | Knarr, Christiane        | LK 4A | Cherokee Cool Rainman | Wallach |            | PH   | 2012 |
| 202 | Zschörper, Mila          | LK 5B | Sam                   | Wallach | SACHS      | WGPo | 2002 |
| 203 | Borrack, Matthias        | LK 2A | FF Play My CD         | Hengst  | B/BRA      | QH   | 1999 |
| 204 | Rautenberg, Myra         | LK 1B | FF Play My CD         | Hengst  | B/BRA      | QH   | 1999 |
| 205 | Haschlar, Antje          | LK 3A | Poco Leo Sterling     | Wallach | SACHS      | QH   | 2008 |





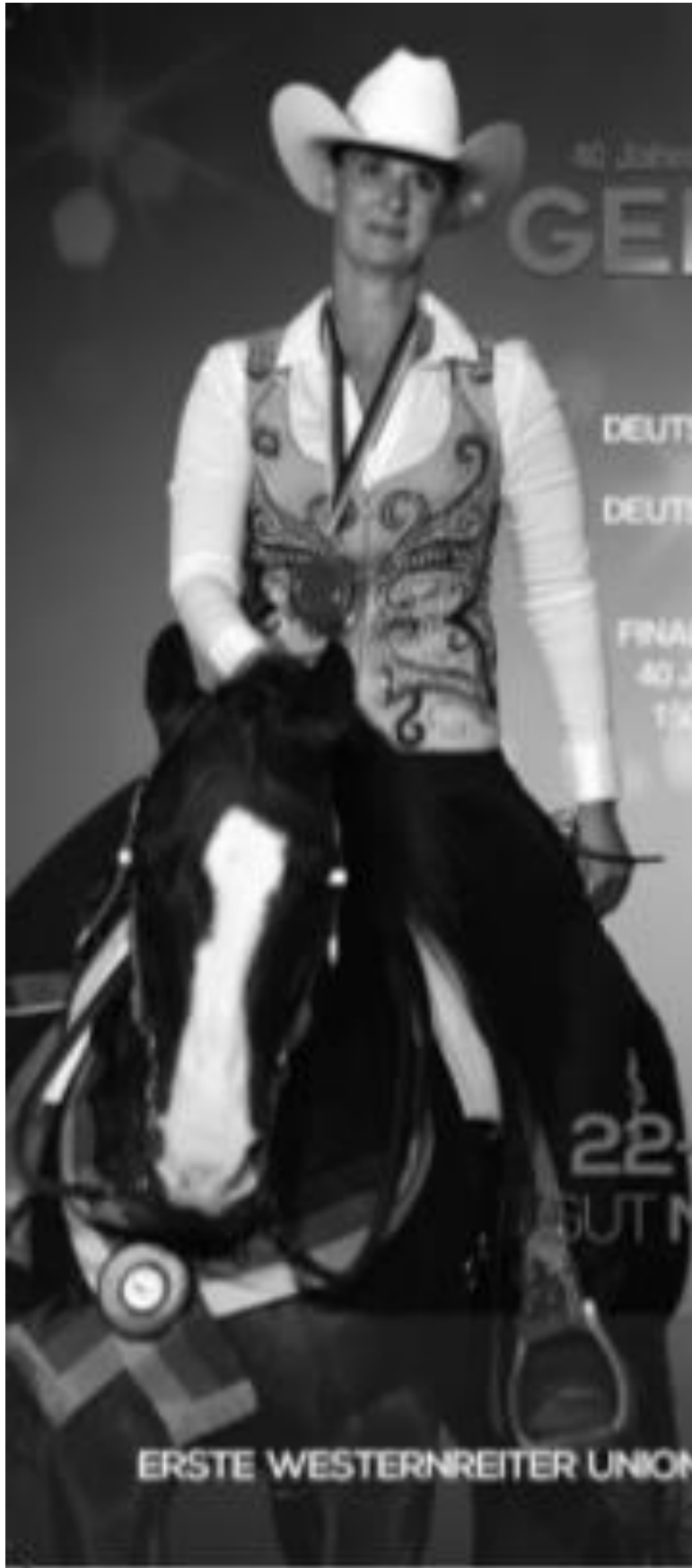

40 Jahre EWU Deutschland e.V.

# GERMAN OPEN

DEUTSCHE MEISTERSCHAFT  
WESTERNREITEN  
DEUTSCHE MEISTERSCHAFT  
MANNSCHAFTEN  
JUGENDSENIOREN  
FINALE LK 3 SPORT AWARD  
40 JAHRE EWU SHOW CUP  
150.000 EURO PREISGELD



FACHVORTRÄGE  
MITMACH-EVENTS  
KINDER PROGRAMM  
SHOPPING  
WINNERS PARTY  
SA 29.09.18

22-29.09.18

GUT MATHESHOFF

KREUTH REGEN



Erste Westernreiter Union  
Deutschland e.V.

ERSTE WESTERNREITER UNION DEUTSCHLAND e.V.

[www.westernreiter.com](http://www.westernreiter.com)