



Chrom-Ranch.de

**CHROM RANCH**

# **EWU & TURNIER**

**05./06. JULI 2025**

**JACKPOT RANCH RIDING  
JACKPOT SHOWMANSHIP  
SONDERPRÜFUNGEN FÜR JUNGE PFERDE**



**RICHTERIN:  
VRENI SCHMID**

## **KONTAKT:**

**info@chrom-ranch.de www.chrom-ranch.eu**

**Reitsportanlage Chrom Ranch**

**Im Dickenreis 61**

**87700 Memmingen**

**Phone: 0174/1606694**





# EWU –C-Turnier Memmingen – Chrom-Ranch

Turnierkategorie:	EWU – C
Datum:	04.07. – 05.07.2025
Veranstaltungsort:	Chrom-Ranch, Im Dickenreis 61, 87700 Memmingen
Veranstalter/ Turnierleiter:	Conrad Feld
Meldestelle:	Peter Voß
Richter:	Vreni Schmid (CH)
Ringsteward:	Silke Ziebart
EWU-Steward:	Maria Holz
Doorman/ Parcours- und Schleifendienst:	Chrom-Ranch Show Team
Turniertierarzt:	Dr. Hofmann 08331-2823
Sanitätsdienst:	Jürgen Ochrana
Hufschmied:	Conrad Feld
Rettungsdienst:	112

**Samstag, ab 20.00 Uhr:**  
**Texas Longhorn Burger/  
Veggie Burger  
und 1 Getränk (Limo/Bier)  
für 10€**

**Anmeldung erbeten!**

# EWU-Turnier: C - Turnier Memmingen 87700 Memmingen



## Zeitplan



### Öffnungszeiten der Meldestelle

04.07.2025: 15:30 - 19:30

05.07.2025: 06:00 - 19:00

06.07.2025: 06:00 - 17:00

### Abreitezeiten

04.07.2025: 16:00 - 20:30

(Halle von 18:00 - 19:00 Uhr gesperrt für PWU)

05.07.2025: 06:00 - 20:00

06.07.2025: 06:00 - 17:00

Anreise am 04.07.2025 ab 15 Uhr möglich.

PWU-Trail in der Halle: 04.07.2025 18:00 bis ca 19 Uhr (Verzögerungen sind möglich)

### **05.07.2025**

### **Halle**

07:00 - 07:20	LK 4/5A Showmanship at Halter	Nennungen: 7
07:20 - 07:30	LK 4/5B Showmanship at Halter	Nennungen: 4
07:30 - 07:50	LK 3 Showmanship at Halter	Nennungen: 7
07:50 - 08:05	LK 1/2 Showmanship at Halter	Nennungen: 5
08:05 - 08:25	LK 4 Western Pleasure	Nennungen: 9
08:25 - 08:45	LK 5 Western Pleasure	Nennungen: 9
08:45 - 09:00	Walk Trot Pleasure Erwachsene	Nennungen: 3
09:00 - 09:15	Walk Trot Pleasure Jugend	Nennungen: 4
09:15 - 09:35	LK 3B Western Pleasure	Nennungen: 6
09:35 - 10:05	LK 3A Western Pleasure	Nennungen: 15
10:05 - 10:25	LK 1/2A Western Pleasure	Nennungen: 6
10:25 - 10:40	LK 1/2B Western Pleasure	Nennungen: 4
10:40 - 11:05	Getränke-Pleasure	Nennungen: 19
11:05 - 11:35	LK 4/5A Western Horsemanship	Nennungen: 10
11:35 - 11:55	LK 4/5B Western Horsemanship	Nennungen: 7
11:55 - 12:10	Walk Trot Horsemanship Erwachsene	Nennungen: 3
12:10 - 12:30	Walk Trot Horsemanship Jugend	Nennungen: 7
12:30 - 13:00	LK 1-3B Western Horsemanship	Nennungen: 9
13:00 - 13:30	Pause	
13:30 - 14:20	LK 3A Western Horsemanship	Nennungen: 20
14:20 - 14:50	LK 1/2A Western Horsemanship	Nennungen: 11
14:50 - 15:00	LK 5A Ranch Riding	Nennungen: 4
15:00 - 15:20	LK 4A Ranch Riding	Nennungen: 7
15:20 - 15:40	LK 4/5B Ranch Riding	Nennungen: 7
15:40 - 16:35	LK 3A Ranch Riding	Nennungen: 21
16:35 - 16:55	LK 3B Ranch Riding	Nennungen: 7
16:55 - 17:25	LK 1/2A Ranch Riding	Nennungen: 12
17:25 - 17:40	LK 1/2B Ranch Riding	Nennungen: 5
17:40 - 18:00	Walk Trot Ranch Riding	Nennungen: 7
18:00 - 18:25	Jackpot Ranch Riding LK 1-5	Nennungen: 10



**Samstag, ab 20.00 Uhr:**

**Texas Longhorn Burger/  
Veggie Burger  
und 1 Getränk (Limo/Bier)  
für 10€**



**Anmeldung erbeten!**



**WESTERNREITVEREIN  
CHROM RANCH E. V.**



**Flohmarkt  
für Western- und  
Hunter Ausrüstung und  
Turnierkleidung und  
-zubehör**





## Zeitplan



### Öffnungszeiten der Meldestelle

04.07.2025: 15:30 - 19:30

05.07.2025: 06:00 - 19:00

06.07.2025: 06:00 - 17:00

### Abreitezeiten

04.07.2025: 16:00 - 20:30

(Halle von 18:00 - 19:00 Uhr gesperrt für PWU)

05.07.2025: 06:00 - 20:00

06.07.2025: 06:00 - 17:00

Anreise am 04.07.2025 ab 15 Uhr möglich.

PWU-Trail in der Halle: 04.07.2025 18:00 bis ca 19 Uhr (Verzögerungen sind möglich)

### **06.07.2025**

### **Halle**

07:00 - 07:10	SO Trail in Hand LK 1-5	Nennungen: 4
07:10 - 07:20	Walk Trot Trail	Nennungen: 2
07:20 - 07:40	LK 4/5B Trail	Nennungen: 6
07:40 - 07:55	LK 5A Trail	Nennungen: 4
07:55 - 08:25	LK 4A Trail	Nennungen: 9
08:25 - 09:10	LK 3A Trail	Nennungen: 15
09:10 - 09:35	LK 3B Trail	Nennungen: 7
09:35 - 10:10	LK 1/2A Trail	Nennungen: 11
10:10 - 10:25	LK 1/2B Trail	Nennungen: 5
10:25 - 10:40	SO Greenhorse Trail	Nennungen: 6
10:40 - 11:10	Jackpot Ranch Trail LK 4/5	Nennungen: 7
11:10 - 12:00	Jackpot Ranch Trail LK 1-3	Nennungen: 16
12:00 - 12:30	Pause	
12:30 - 12:45	Führzügelklasse	Nennungen: 4
anschl.	LK 3B Western Ranch Rail	Nennungen: 7
anschl.	LK 3A Western Ranch Rail	Nennungen: 17
anschl.	LK 1A Western Ranch Rail	Nennungen: 5
anschl.	LK 2A Western Ranch Rail	Nennungen: 5
anschl.	LK 1/2B Western Ranch Rail	Nennungen: 6
anschl.	SO LK 5 Western Ranch Rail	Nennungen: 5
anschl.	LK 4 Western Ranch Rail	Nennungen: 9
anschl.	SO Greenhorse Ranch Riding	Nennungen: 11
anschl.	LK 1-3 Western Riding	Nennungen: 9
anschl.	LK 1/2 Reining	Nennungen: 5
anschl.	LK 4 Reining	Nennungen: 1
anschl.	LK 3 Reining	Nennungen: 4

## EWU Turnier: C - Turnier Memmingen

Start Nr.	Reiter	LK	LV	Pferd	Rasse
1	Claudia Schmidt	LK 2A	BAWÜ, RLP	Catalena Tivio	QH
	LK 1-3 WR ,LK 1/2 A RR ,LK 1/2 A TH ,LK 1/2 A WHS ,LK 2A WRR ,SO JP RR LK 1-5 ,SO RT LK 1-3				
2	Britta Sassenburg	LK 3A	BAWÜ	MM Dun It Lil Hazel	QH
	LK 3 SSH ,LK 3A RR ,LK 3A TH ,LK 3A WHS ,LK 3A WPL ,LK 3A WRR				
3	Anja Martin	LK 3A	BAWÜ	Quelen Tamano	CR
	LK 1-3 WR ,LK 3A TH ,LK 3A WRR ,SO RT LK 1-3				
4	Martina Stemmler	LK 1A	BAY	PO Cherokee Bunny	PH
	LK 1-3 WR ,LK 1/2 A RR ,LK 1/2 A TH ,LK 1/2 A WHS ,LK 1/2 A WPL ,LK 1A WRR				
5	Elisabeth Benzing	LK 2A	BAY	AC Colonel Frost	QH
	LK 1/2 A RR ,LK 1/2 A TH ,LK 1/2 A WHS ,LK 2A WRR ,SO RT LK 1-3				
6	Annika Stöckle	LK 3A	BAWÜ	Agitada Delicia	CR
	LK 3A TH ,LK 3A WRR ,SO RT LK 1-3				
7	Lisa Groba	LK 4B	BAY	PO Cherokee Bunny	PH
	LK 4 WPL ,LK 4 WRR ,LK 4/5 B RR				
8	Franziska Garbotz	LK 5B		AC Colonel Frost	QH
	LK 4/5 B TH ,LK 4/5 B WHS				
9	Ramona Arnold	LK 3A	BAY	Smartest Equilizer	QH
	LK 3 RN ,LK 3A RR ,LK 3A TH ,LK 3A WHS ,LK 3A WPL ,LK 3A WRR				
10	Jana Eschenlohr	LK 3B	BAY	Miss Baby Jess	QH
	LK 1-3 B WHS ,LK 3B RR ,LK 3B TH ,LK 3B WPL ,LK 3B WRR				
11	Francesca Weyrauch	LK 1B	BAY	Jacs Dunit Surprise	QH
	LK 1/2 B RR ,LK 1/2 B TH ,LK 1/2 B WPL ,LK 1/2B WRR				
12	Viola Weyrauch	LK 4A	BAY	Jacs Dunit Surprise	QH
	LK 4/5 A WHS ,LK 4A TH				
13	Diana Kirschner-Kurz	LK 1A	BAWÜ	Josie	TI
	LK 1/2 A RR ,LK 1/2 A TH ,LK 1/2 A WHS ,LK 1/2 SSH ,LK 1A WRR ,SO JP RR LK 1-5 ,SO RT LK 1-3				
14	Katharina Ettensperger	LK 4A	BAY	PPR Sakimas Averell	PHM
	LK 4 WRR ,SO GH RR ,SO GH TH				
15	Sandra Gröbl	LK 3A	BAY	FR Hope Doc Bar	PH
	LK 3 RN ,LK 3 SSH ,LK 3A RR ,LK 3A WHS ,LK 3A WRR ,SO RT LK 1-3				
16	Sabrina Botur	LK 1A	BAY	PG Jo N Dry	QH
	LK 1/2 A RR ,LK 1/2 A TH ,LK 1/2 RN				
17	Mareike Schilling	LK 3A	BAY	Thee Good Time Asset	QH
	LK 3A RR ,LK 3A TH ,LK 3A WHS ,LK 3A WPL ,LK 3A WRR ,SO GH RR ,SO GH TH				
18	Catrin Zimmermann	LK 2A	BAWÜ	REMYDEMY CHEX BAY	QH
	LK 1/2 A RR ,LK 1/2 A TH ,LK 1/2 A WHS ,LK 2A WRR ,SO Getränke WPL ,SO JP RR LK 1-5 ,SO RT LK 1-3				
19	Petra Arnold	LK 5A		Smartest Equilizer	QH
	LK 4/5 A WHS ,LK 5A RR ,LK 5A TH ,SO LK 5 WRR				
20	Alice Kovalova - Müller	LK 4A	BAWÜ	Andy Pandy	IC
	LK 4 WRR ,LK 4A TH ,SO RT LK 4/5				
21	Alice Kovalova - Müller	LK 4A	BAWÜ	ZABARA FOR GAMP	QArb
	LK 4A TH ,SO GH RR ,SO GH TH ,SO RT LK 4/5				
22	Janine Winter	LK 3A	BAWÜ	Peppys Perfect Leary	QH
	LK 3A RR ,LK 3A TH ,LK 3A WHS ,LK 3A WPL ,LK 3A WRR ,SO RT LK 1-3				
23	Maximilian Vaihinger	LK 5A		Peppys Perfect Leary	QH
	WT WHS A ,WT WPL A				



## EWU Turnier: C - Turnier Memmingen

24 Ronja Prinz LK 4/5 A SSH ,LK 4/5 A WHS ,LK 4A RR ,LK 4A TH	LK 4A	BAWÜ	Cinderella	PinPo
25 Pia Weitzenegger WT RR ,WT WHS B ,WT WPL B	LK 5B		Rubin	Isl.
26 Shila Ekiz LK 3A RR ,LK 3A TH ,LK 3A WHS ,LK 3A WPL ,LK 3A WRR ,SO Getränke WPL ,SO GH TH	LK 3A	BAY	Amazing on my Own	PH
27 Marilena Rabl LK 1/2 A RR ,LK 1/2 A WHS ,LK 1/2 A WPL	LK 2A	BAY	Stylish Cruzader	QH
28 Christoph Andries LK 4 WRR ,LK 4/5 B RR ,LK 4/5 B WHS ,SO GH RR	LK 4B	BAWÜ	Full Chex Up	QH
29 Finja Pfau LK 4/5 B RR ,LK 4/5 B SSH ,LK 4/5 B TH ,LK 4/5 B WHS ,LK 5 WPL ,SO LK 5 WRR	LK 5B		Dunkellin Black Beauty	TI
30 Nina Cutruneo LK 3A RR ,LK 3A WHS ,LK 3A WPL ,SO Getränke WPL ,SO JP RR LK 1-5	LK 3A	BAWÜ	Choclate Boomchic	QH
31 Marie-Sophie Waitzinger LK 1-3 B WHS ,LK 3 SSH ,LK 3B RR ,LK 3B TH ,LK 3B WPL ,LK 3B WRR ,SO Getränke WPL	LK 3B	BAY	My Kinda Fix	QH
32 Amelie Mayer WT WHS B ,WT WPL B	LK 5B		JQ Miss Jacky D	PH
33 Bianca Miller LK 1/2 A WHS ,LK 1/2 A WPL ,LK 1/2 SSH ,SO Getränke WPL	LK 2A	BAY	Anytimes Bigsensation	PH
34 Anna Kreittner LK 1-3 B WHS ,LK 3B RR ,LK 3B TH ,LK 3B WPL ,LK 3B WRR ,SO Getränke WPL	LK 3B	BAY	Kamilla	LW
35 Stefanie Zech LK 1/2 A RR ,LK 1/2 RN ,LK 1A WRR	LK 1A	BAY	Oban on the rocks	QH
36 Chiara Simon LK 3A RR ,LK 3A WHS ,LK 3A WPL ,LK 3A WRR	LK 3A	BAY	Wimpys White Rose	QH
37 Luka Hipp LK 4/5 A SSH ,LK 4/5 A WHS ,LK 5A RR	LK 5A		Cody 137	Son.Pf
38 Enni Deutschenbaur WT RR ,WT TH ,WT WHS B	LK 5B		Lite Rock	QH
39 Romy Edelhäuser SO SO FZ	LK 5B	BAWÜ	Chanel vom Ellernbrook	ShMin
40 Magdalena Paulik LK 3 RN ,SO GH RR	LK 3A	BAY	Screenshot Prairie	PHS
41 Mia Habon LK 1-3 B WHS ,LK 1-3 WR ,LK 3B RR ,LK 3B TH ,LK 3B WRR ,SO JP RR LK 1-5	LK 3B	BAWÜ	Whiskey To Cash	QH
42 Katharina-Sophia Gschwendtner LK 1-3 WR ,LK 3A RR ,LK 3A TH ,LK 3A WHS ,LK 3A WPL ,LK 3A WRR ,SO Getränke WPL	LK 3A	BAY	LR Slide With Saints	QH
43 Dana Albrecht LK 3A WHS ,SO Getränke WPL	LK 3A	BAY	SQ Spice Girl Lucy	PH
44 Lena Rösch WT RR ,WT WHS B ,WT WPL B	LK 5B		Lucy	NRPS
45 Elisabeth Panzer LK 1-3 B WHS ,LK 1/2 B RR ,LK 1/2 B TH ,LK 1/2 B WPL ,LK 1/2 SSH ,LK 1/2B WRR	LK 2B	BAWÜ	Gill Gun	PH
46 Elisa Heinzmann LK 1-3 WR ,LK 1/2 A TH ,LK 2A WRR ,SO RT LK 1-3	LK 2A	BAY	Stylish Cruzader	QH
47 Mia Gabriella Klumpp LK 1/2 B RR ,LK 1/2B WRR ,SO GH RR	LK 2B	BAWÜ, BAY	Roosters Red Romance	QH

## EWU Turnier: C - Turnier Memmingen

48 Patrick Klumpp LK 3A RR ,LK 3A WRR ,SO GH RR	LK 3A	BAWÜ	Little Spooky Wooky	QH
49 Traudl Drechsler LK 3A WHS ,SO Getränke WPL	LK 3A	BAY	JQ Miss Jacky D	PH
50 Doris Voichtleitner LK 3A WHS ,LK 3A WPL ,SO Getränke WPL	LK 3A	BAY	Sóley Surprise	QP
51 Josephine Rudolf LK 1/2 A RR ,LK 1/2 A TH ,LK 1/2 A WHS ,LK 1/2 SSH ,SO JP RR LK 1-5 ,SO RT LK 1-3	LK 1A	BAY	The Candy Factory	QH
52 Laura Grünauer LK 1-3 B WHS ,LK 1/2 B RR ,LK 1/2 B TH ,LK 1/2 B WPL ,LK 1/2B WRR	LK 2B	BAY	Sammy	WGPo
53 Laura Grünauer	LK 2B	BAY	Bambi	WGP
54 Carolin Prechtl LK 3A RR ,LK 3A WHS ,LK 3A WPL	LK 3A	BAWÜ	Crispy Chic N	QH
55 Paula Bianca Kiewitt LK 1-3 B WHS ,LK 3B RR ,LK 3B TH ,LK 3B WPL ,LK 3B WRR	LK 3B	BAWÜ	Smart View Sue	QH
56 Lena Schmid LK 1/2 B TH ,LK 1/2 SSH ,LK 1/2B WRR ,SO Getränke WPL	LK 1B	BAY	Her Jeans Fit Good	PH
57 Milena Stemmler SO SO FZ	LK 5B		PO Cherokee Bunny	PH
58 Shania Palatin LK 4 WPL ,LK 4/5 A WHS ,LK 4A RR	LK 4A	BAY	Bo S Kid On Fire	APP
59 Martina Krauß LK 3A RR ,LK 3A WHS ,LK 3A WPL	LK 3A	BAWÜ	Nu Q Tee	QH
60 Sabrina Botur SO GH RR ,SO GH TH	LK 1A	BAY	PKMedleysTripleL	QH
61 Franka Krauß LK 4/5 B RR ,LK 4/5 B WHS	LK 4B	BAWÜ	Nu Q Tee	QH
62 Nina Schrade LK 3 SSH ,LK 3A RR ,LK 3A TH ,LK 3A WHS ,LK 3A WPL ,LK 3A WRR ,SO THiiH LK 1-5	LK 3A	BAWÜ	AMAZING BE AECH	QH
63 Nadja Isabell Fellingner LK 4 WPL ,LK 4/5 A SSH ,LK 4/5 A WHS ,LK 4A RR	LK 4A	BAWÜ	Thorin	SK
64 Doris Schmied LK 1-3 WR ,LK 3 SSH ,LK 3A RR ,LK 3A TH ,LK 3A WHS ,LK 3A WPL ,LK 3A WRR ,SO JP RR LK 1-5 ,SO RT LK 1-3	LK 3A	BAY	Zipnotic	PH
65 Kathrin Ochrana LK 4/5 A SSH ,LK 5 WPL ,LK 5A RR ,LK 5A TH ,SO Getränke WPL ,SO LK 5 WRR ,SO RT LK 4/5 ,SO THiiH LK 1-5	LK 5A	BAY	Lite Rock	QH
66 Giorgia de Santis WT RR ,WT WHS B	LK 5B		San Hollywood Cuebar	QH
67 Johanna Wolf LK 4 WPL ,LK 4 WRR ,LK 4A RR ,LK 4A TH	LK 4A	BAY	ITS Coffee Time	QH
68 Lena Heißwolf LK 1/2 B RR ,LK 1/2 B TH ,LK 1/2 B WPL ,LK 1/2 RN ,LK 1/2B WRR ,SO Getränke WPL ,SO JP RR LK 1-5 ,SO RT LK 1-3	LK 2B	BAY	ITS Coffee Time	QH
69 Ines Eckstein WT RR ,WT TH ,WT WHS A ,WT WPL A	LK 4A	BAY	A Magic Invitation	APP
70 Julia Schmid LK 4 WPL ,LK 4 WRR ,LK 4/5 A SSH ,LK 4/5 A WHS ,LK 4A RR ,LK 4A TH ,SO RT LK 4/5	LK 4A	BAY	KRYMSUNSZIPSCHOCOLATE	PH



## EWU Turnier: C - Turnier Memmingen

71 Miriam Diepolder LK 4 WRR ,SO GH RR	LK 4B	BAY	Medleys Little Gunner	Wel.B
72 Angelika Feld LK 1/2 A TH ,LK 1/2 A WHS ,LK 1/2 A WPL ,SO Getränke WPL ,SO RT LK 1-3	LK 1A	BAY	Sheza Hot Sweet Chip	PH
73 Melanie Scheder LK 5A TH ,SO LK 5 WRR ,SO RT LK 4/5	LK 5A		My Kinda Fix	QH
74 Tanja Peukert LK 3 SSH ,LK 3A RR ,LK 3A TH ,LK 3A WHS ,LK 3A WRR ,SO Getränke WPL ,SO THiH LK 1-5	LK 3A	BAY	Guaranteed To Luvme	PH
75 Romi Beck LK 4 WPL ,LK 4/5 B RR ,LK 4/5 B WHS ,SO Getränke WPL	LK 4B	BAWÜ	Maiky Chex	PHM
76 Johanna Schelle LK 1-3 B WHS ,LK 3B RR ,LK 3B TH ,LK 3B WPL ,LK 3B WRR ,SO Getränke WPL	LK 3B	BAY	Dahira	ARB
77 Viola Menner WT RR ,WT WHS A ,WT WPL A	LK 4A	BAWÜ	Thee Final Rock	QH
78 Daniel Rohde LK 4/5 A SSH ,LK 5A TH	LK 5A	BAWÜ	Cluespretty Technique	PH
79 Werner Spiel LK 4/5 A WHS ,LK 5 WPL ,LK 5A RR ,SO LK 5 WRR ,SO RT LK 4/5	LK 5A	BAY	Cluespretty Technique	PH
80 Corinna Klaus LK 4 WPL ,LK 4/5 A WHS ,LK 4A RR ,LK 4A TH ,SO Getränke WPL	LK 4A	BAY	Rock Me Ms Goodie	QH
81 Emma Zwißler LK 4/5 B SSH ,LK 5 WPL	LK 5B		Paint Me Really Fancy	PH
82 Isabella Amalia Klumpff WT RR ,WT WHS B	LK 4B	BAWÜ	Little Spooky Wooky	QH
83 Luise Litz LK 5 WPL	LK 5B		Maiky Chex	PHM
84 Kathrin Rohde LK 4 WPL ,LK 4/5 A SSH ,LK 4/5 A WHS ,LK 4A TH	LK 4A	BAWÜ	Goodandsensational	PH
85 Emma Hierlemann LK 1-3 B WHS ,LK 3 SSH ,LK 3B RR ,LK 3B TH ,LK 3B WPL ,LK 3B WRR	LK 3B	BAWÜ	Cinderella	PinPo
86 Kristin Schäfer LK 3A RR ,LK 3A WHS	LK 3A	BAWÜ	La Nevada El Relámpago	CR
87 Lina Schmid WT WHS B ,WT WPL B	LK 5B	BAY	KRYMSUNSZIPSCHOCOLATE	PH
88 Andrea Spiegler LK 3A RR ,LK 3A WPL	LK 3A	BAY	Bo S Acre Girl	QH
89 Julia Spiegler SO SO FZ	LK 5B		I Am Cindy Rooster	QH
90 Franziska Steinhauser LK 4/5 B RR ,LK 4/5 B TH ,LK 4/5 B WHS ,LK 5 WPL	LK 5B	BAWÜ	Flocke vom Federsee	SK
91 Elisa Dürr LK 4/5 B TH	LK 5B		Rock Me Ms Goodie	QH
92 Franziska Haug LK 1/2 A RR ,LK 1/2 RN ,LK 1A WRR ,SO JP RR LK 1-5 ,SO RT LK 1-3	LK 1A	BAWÜ	Chic N Shiny	QH
93 Selina Maurus LK 1/2 A RR ,LK 1/2 A WHS ,LK 1/2 A WPL ,LK 1/2 RN ,LK 2A WRR	LK 2A	BAWÜ	JB Cherokees last Gun	PH
94 Jürgen Ochrana LK 1-3 WR ,LK 1/2 A TH ,LK 1/2 A WHS ,LK 1/2 A WPL	LK 2A	BAY	Brunettes Only	PH

## EWU Turnier: C - Turnier Memmingen

95 Selina Reiser LK 4 WPL ,LK 4 WRR ,LK 4A RR	LK 4A	BAY	Jessy's Lil Jaylee	QP
96 Angie Heißwolf LK 1/2 A RR ,LK 1/2 A TH ,LK 1A WRR ,SO RT LK 1-3	LK 1A	BAY	Jessy's Lil Jaylee	QP
97 Chantal Rebl LK 3A RR ,LK 3A WHS ,LK 3A WPL ,LK 3A WRR	LK 3A	BAY	Jessy's Lil Jaylee	QP
98 Corina März LK 3A RR ,LK 3A TH	LK 3A	BAY	Topdun D Four Bagder	QH
99 Michael März LK 1-3 WR ,LK 3A RR ,LK 3A TH ,LK 3A WRR ,SO JP RR LK 1-5 ,SO RT LK 1-3	LK 3A	BAY	Kings Equalizer Jane	QH
100 Robert Mugrauer LK 3A RR ,LK 3A TH ,LK 3A WHS	LK 3A	BAY	Lady Mary Lou	WGP
101 Martha Morbach LK 4/5 B RR ,LK 4/5 B WHS ,LK 5 WPL ,SO Getränke WPL	LK 5B		Medley´s Pushkin Red Sun	WP
102 Lara Felice Sax LK 4/5 B SSH ,LK 4/5 B TH ,LK 5 WPL	LK 5B		Chip Zip	PH
103 Angelina Kiel LK 4/5 B SSH ,LK 4/5 B TH ,LK 5 WPL	LK 5B		Sheza Really Princess	PH
104 Miriam Knotek LK 3A TH ,SO THiH LK 1-5	LK 3A	BAY	Top Dream Vegas (Gino)	QP
105 Corinna Mayer LK 4 WRR ,LK 4A TH ,SO RT LK 4/5	LK 4A	BAY	Django	Son.P
106 Franziska Kirchbichler LK 3 RN ,LK 3A WRR ,SO GH RR	LK 3A	BAY	Dunnits Jackie	PH
107 Clemens Hefel LK 4 RN	LK 4A	BAY	QM Wimpys Elliott	QH
108 Michelle Herz SO GH RR ,SO GH TH	LK 3A	BAWÜ	Be a Poker	QHM
109 David Herz SO SO FZ	LK 5B		Be a Poker	QHM



**GlüMaManufaktur**  
Coaching-Training-Consulting New Work

*Emotional intelligent führen - sich und andere.  
Empathisch wachsen. Nachhaltig wirken.*

**SCAN ME**  Mehr erfahren

**Franziska Schewe** | Personenzertifizierte Trainer, Coach und Consultant New Work EN ISO/IEC 17024  
+49-174-3312862 | office@gluemamanufaktur.de | Gersbronn 8, 91550 Dinkelsbühl

Follow us 





# EWU BAYERN CUP 2025

## Leistungsklasse 1-4 A/B

- nur Mitglieder der EWU Bayern in der jeweiligen Leistungsklasse LK 1 bis 4 (Jugend und Erwachsene getrennt)
- Punktevergabe erfolgt nur für bayerische Turniere
- einfache Wertung der Punkte inklusive Sonderprüfungen - keine Highpoint Disziplin
- Berechnung erfolgt je Pferd/Reiterkombination

**DIE JEWEILIGEN PLÄTZE 1-5  
WERDEN AUF DER  
"TROPHY PARTY" 2026  
GEEHRT!**



Was es zu gewinnen gibt,  
verraten wir beim Zwischenstand  
im Juni/Juli 2025

Reining Pattern 8

LK 1/2 A/B  
LK 3 A/B

Reining

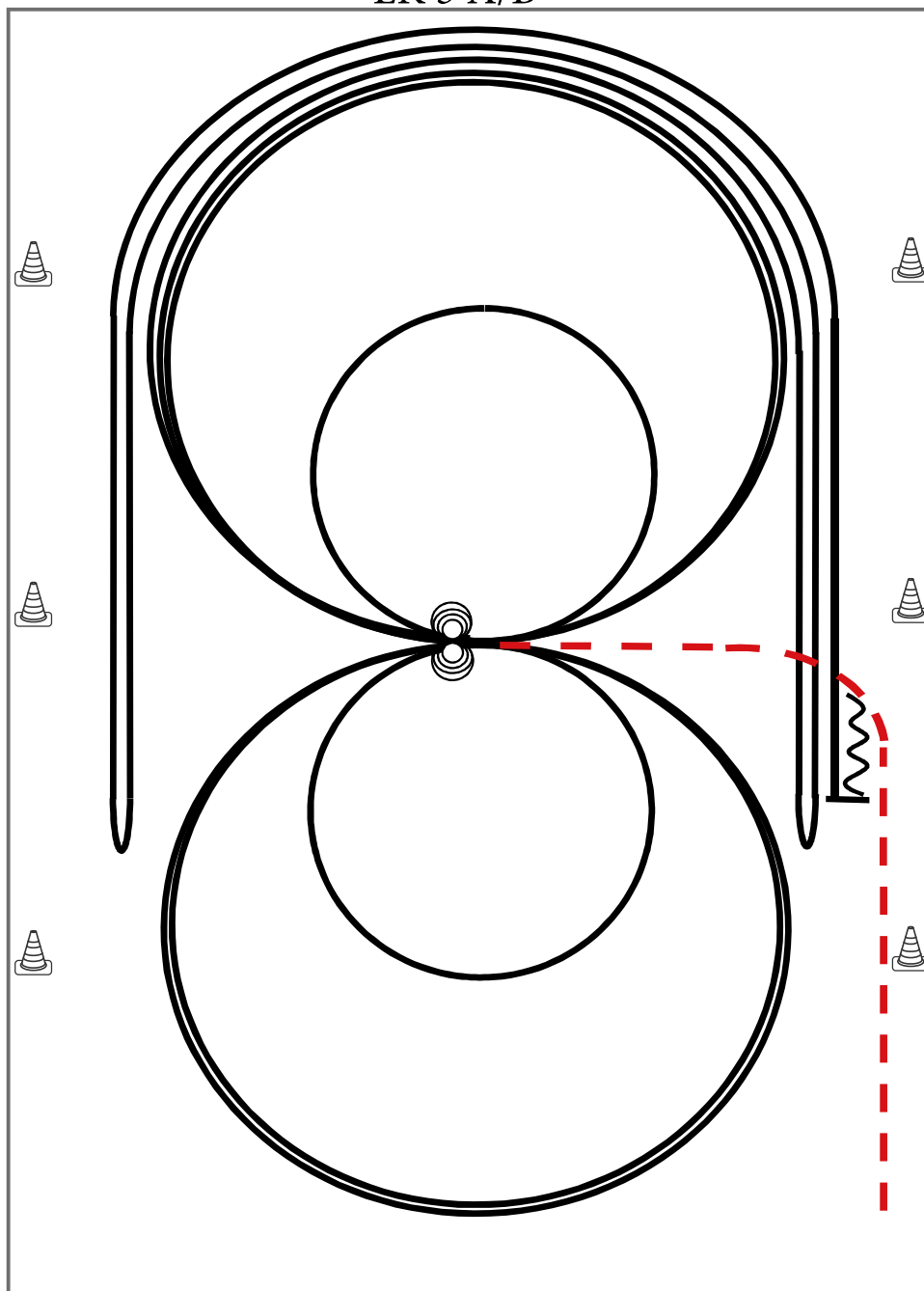

Im Trab zur Mitte der Bahn. Beginn der Aufgabe aus dem Schritt oder aus dem Stand.

- 1) 4 Spins **links**, Verharren
- 2) 4 Spins **rechts**, Verharren
- 3) 3 Zirkel Galopp (**rechts**), 1. groß und schnell, 2. **klein** und langsam, 3. groß und schnell, Galoppwechsel bei X
- 4) 3 Zirkel Galopp (**links**), 1. groß und schnell, 2. **klein** und langsam, 3. groß und schnell, Galoppwechsel bei X
- 5) Galopp (**rechts**) auf dem Zirkel, der nicht geschlossen wird, Run Down entlang der langen Seite, Sliding Stop mind. 6,00 m von der Bande entfernt hinter dem **Mittelmarker**, Rollback **links**, kein Verharren
- 6) Galopp (**links**) auf dem Zirkel, der nicht geschlossen wird, Run Down entlang der langen Seite, Sliding Stop mind. 6,00 m von der Bande entfernt hinter dem **Mittelmarker**, Rollback **rechts**, kein Verharren
- 7) Galopp (rechts) auf dem Zirkel, der nicht geschlossen wird, Run Down entlang der langen Seite, Sliding Stop mind. 6,00 m von der Bande entfernt hinter dem **Mittelmarker**, Rückwärtsrichten mind. 3,00 m, Verharren

Der Reiter muss das Kopfstück zur Gebisskontrolle vor dem Richter abnehmen.

Trab	---
Galopp	—
Rückwärts	⋈



# Reining Pattern 17 (nur für LK 4) LK 4 A/B

Reining

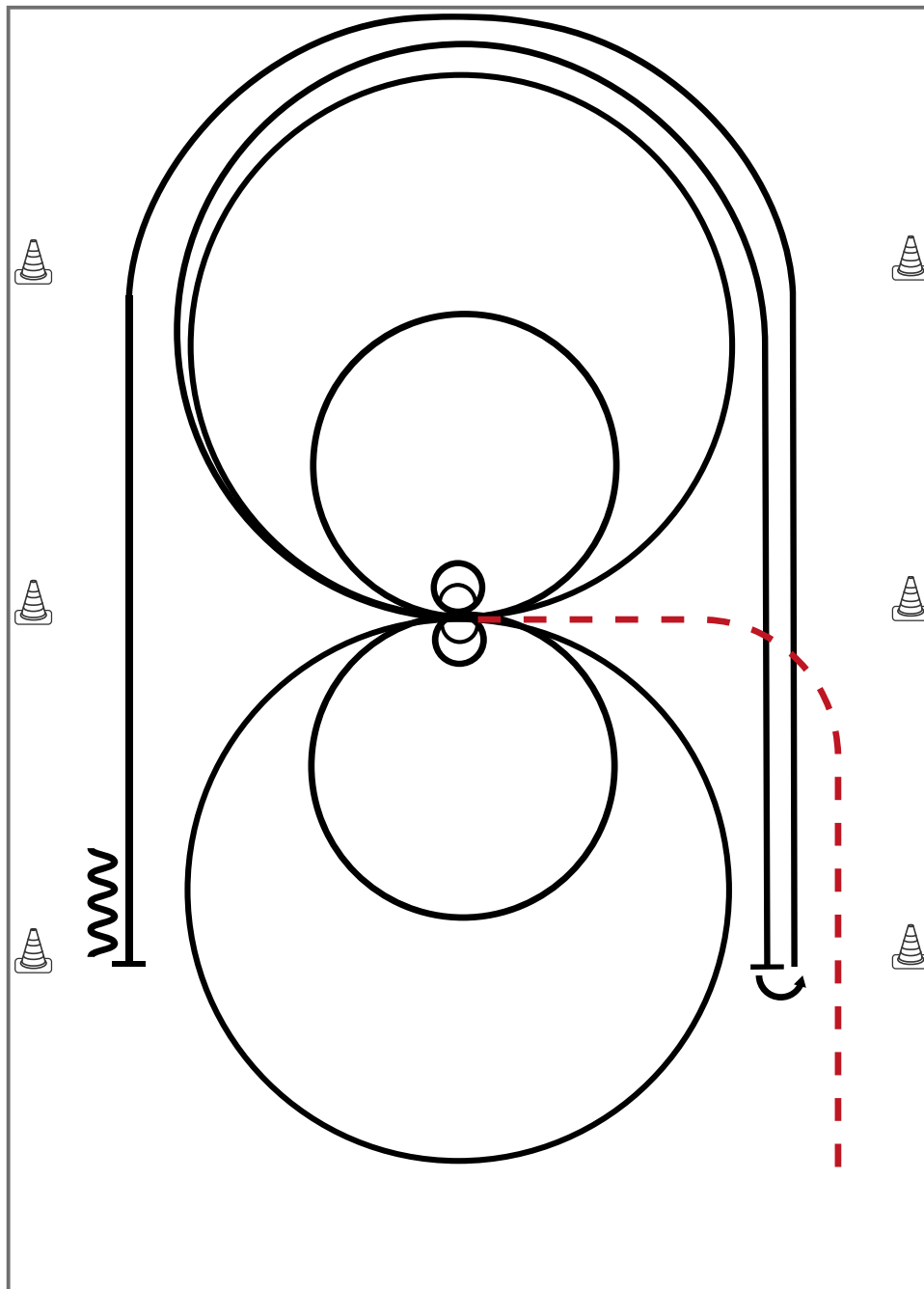

Im Trab zur Mitte der Bahn. Beginn der Aufgabe aus dem Schritt oder Stand.

- 1) 2 Spins links, verharren
- 2) 2 Zirkel links, 1. groß und schnell, **2. klein** und langsam, Stop bei X, verharren
- 3) 2 Spins **rechts**, verharren
- 4) 2 Zirkel **rechts**, 1. groß und schnell, **2. klein** und langsam
- 5) Galopp (**rechts**) auf dem Zirkel, der nicht geschlossen wird, Run Down entlang der langen Seite, Stop mind. 6,00m von der Bande entfernt hinter dem **Mittelmarker**, Rollback **links**, kein Verharren
- 6) Galopp (**links**) auf dem Zirkel, der nicht geschlossen wird, Run Down entlang der langen Seite, Stop mind. 6,00m von der Bande entfernt hinter dem **Mittelmarker**, Rückwärtsrichten mind. 3,00m, Verharren

Trab	---
Galopp	—
Rückwärts	~~~~~

Der Reiter muss das Kopfstück zur Gebisskontrolle vor dem Richter abnehmen.

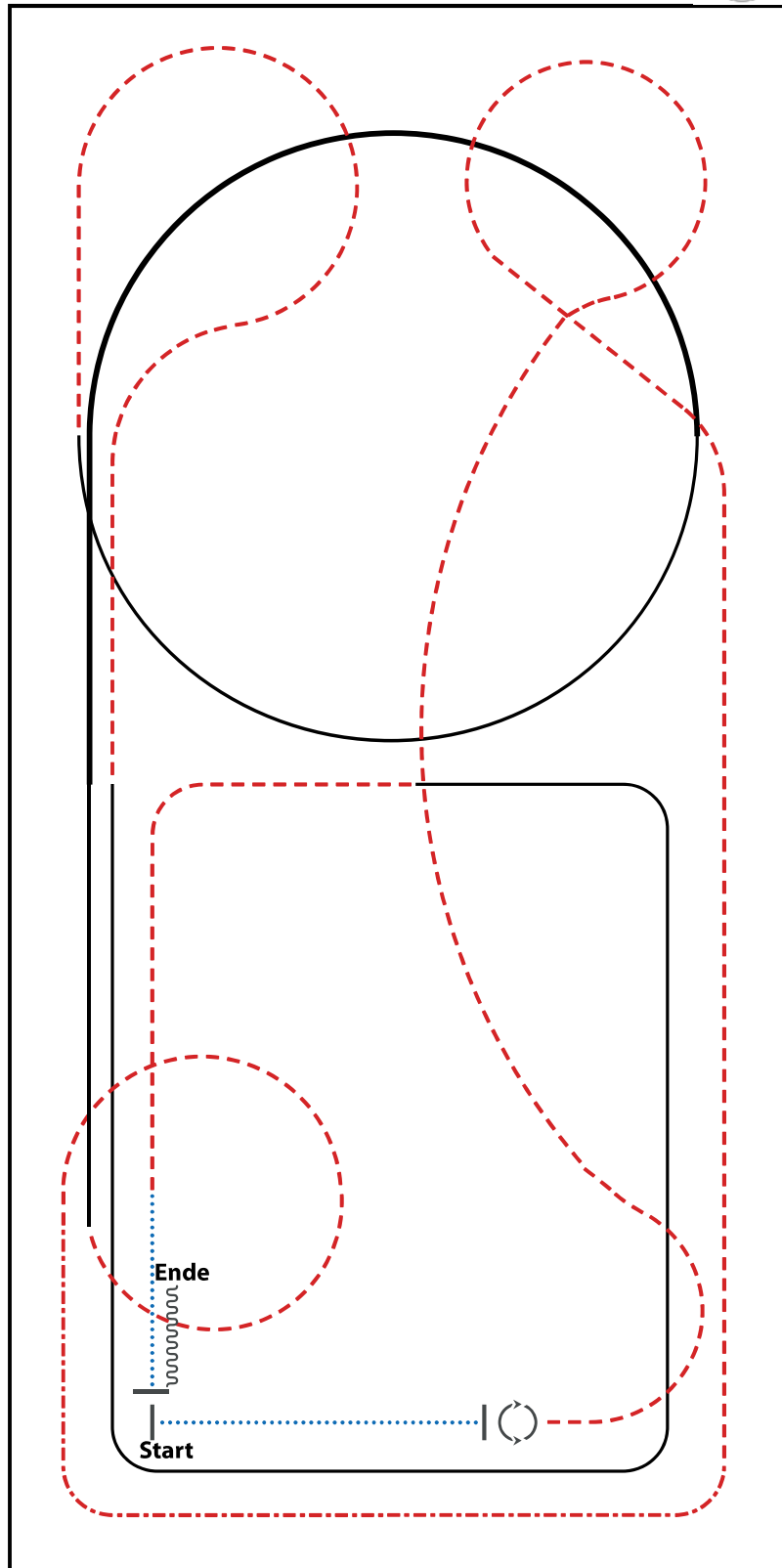

- 1) WALK
- 2) STOP, TURNS 360° (EACH DIRECTION)
- 3) TROT
- 4) EXTENDED TROT, TROT
- 5) LOPE (RL), EXTENDED LOPE (RL), LOPE (RL)
- 6) TROT
- 7) LOPE (LL)
- 8) TROT, WALK
- 9) STOP, BACK UP

WALK (SCHRITT)	
EXTENDED WALK	
JOG/TROT (TRAB)	
EXTENDED TROT	
LOPE (GALOPP)	
EXTENDED LOPE	
BACK UP (RÜCKWÄRTS)	
LEAD CHANGE (GALOPPWECHSEL)	
TURN (DREHUNG)	

ERSTE WESTERNREITER UNION FÜR DEN VERBAND WESTERREITEN



# NEXT LEVEL RANCH RIDING TROPHY 2025

POWERED  
BY



Deutsche  
Vermögensberatung  
TOBIAS KARG



## Teilnahmebedingungen:

- Alle der Leistungsklasse A von 1-5 in der EWU Bayern sind berechtigt.
- Es muss an mindestens 3 Turnieren der EWU Bayern gestartet werden, um in die Wertung zu kommen.
- Um in die Wertung zu kommen, muss eine Mindestanzahl an Starts in der Disziplin "Ranch Riding" erreicht werden:
- LK A 1-2: 5 Starts und LK A 3-5: 3 Starts



## Wertungskriterium:



- Es zählen nur die Punkte in der Ranch Riding\*
- Die Platzierungen werden anhand des durchschnittlichen Punktestands ermittelt.
- Hierbei wird die Gesamtpunktzahl durch die Anzahl der Starts geteilt:
- *Beispiel LK A 1-2: 360 Punkte ÷ 5 Starts = 72,00*
- *Beispiel LK A 3-5: 213 Punkte ÷ 3 Starts = 71,00*
- Der höchste Durchschnitt gewinnt.
- Es zählt immer eine Pferd/Reiter Kombination

\*Es zählen keine Z- und Sonderprüfungen, sowie keine Jungpferdeklassen!

## Was gibt es zu gewinnen?:

Jede Leistungsklasse A von 1-5 werden separat in ihrer LK prämiert von Platz 1-3:

1. Platz: 3 Freistarts\* + Trophy
2. Platz: 2 Freistarts\*
3. Platz: 1 Freistart\*

\*Überreicht werden die Preise auf der Jahreshauptversammlung der EWU Bayern im Jahr 2026. Die Freistarts sind in der Turniersaison 2026 auf den Turnieren der EWU Bayern einlösbar. Ausgenommen sind Qualistarts auf der Double Show in Kreuth. Keine Barauszahlung möglich! Der Rechtsweg ist ausgeschlossen!



0152 27 05 46 56

tobias.karg@dvag.de

SCAN  
ME



www.tobias-karg.dvag



tobiaskarg\_finanzcoaching

Scan den QR-Code und sichere dir dein Gespräch - unverbindlich und kostenlos!  
Nutze dein volles Potential - nicht nur im Sattel! Mehr erreichen - im Sport & bei deinen Finanzen!

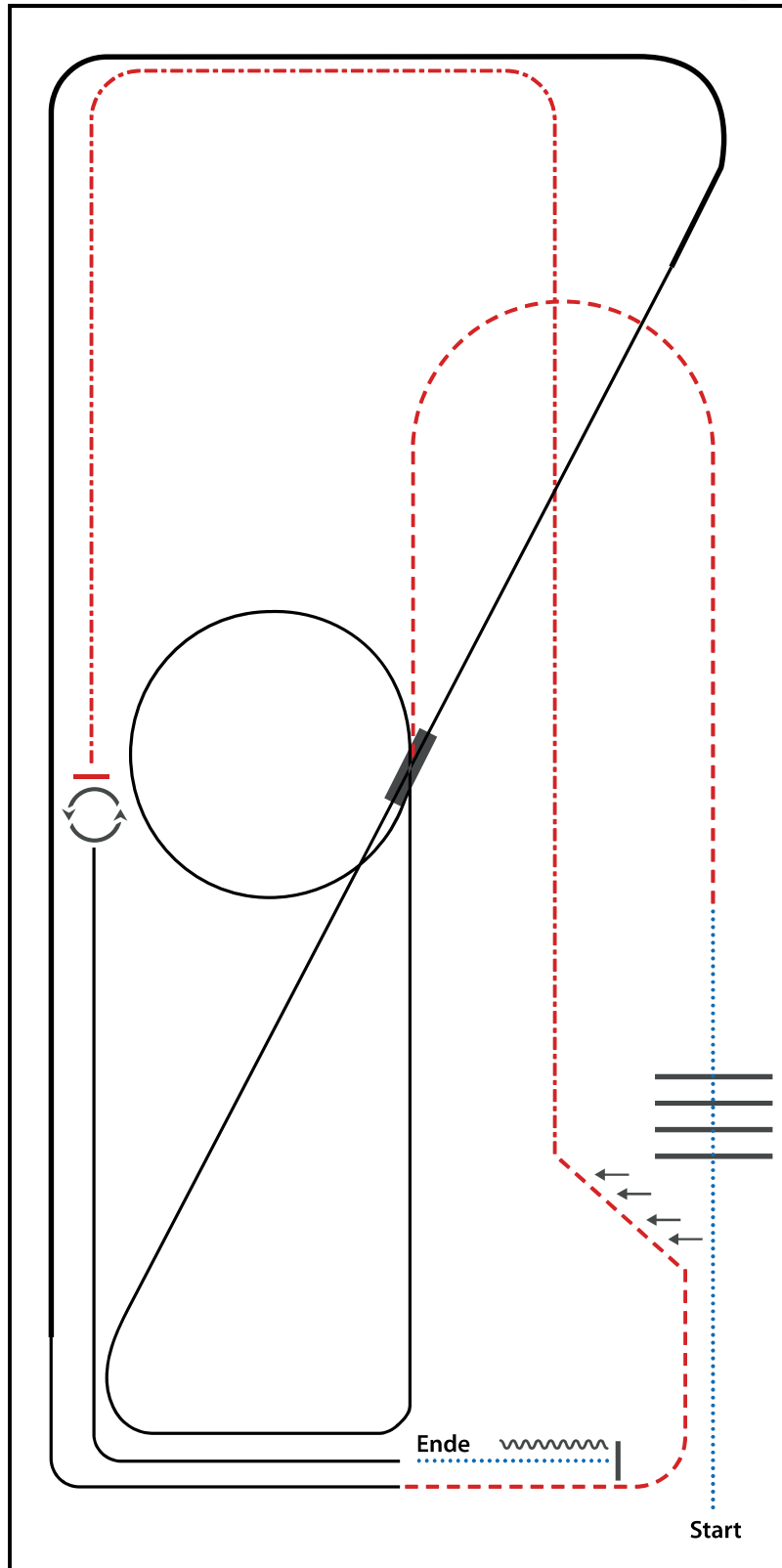

- 1) WALK
- 2) WALK OVER
- 3) TROT
- 4) LOPE (RL) SMALL CIRCLE, LOPE (RL)
- 5) CHANGE LEADS (SIMPLE OR FLYING)
- 6) LOPE (LL)
- 7) EXTENDED LOPE (LL), LOPE (LL)
- 8) TROT, TROT TWO TRACK LEFT
- 9) EXTENDED TROT
- 10) STOP, 360° TURNS (EACH DIRECTION)
- 11) LOPE (LL)
- 12) WALK, STOP, BACK UP

WALK (SCHRITT)	
EXTENDED WALK	
JOG/TROT (TRAB)	
EXTENDED TROT	
LOPE (GALOPP)	
EXTENDED LOPE	
BACK UP (RÜCKWÄRTS)	
LEAD CHANGE (GALOPPWECHSEL)	
TURN (DREHUNG)	

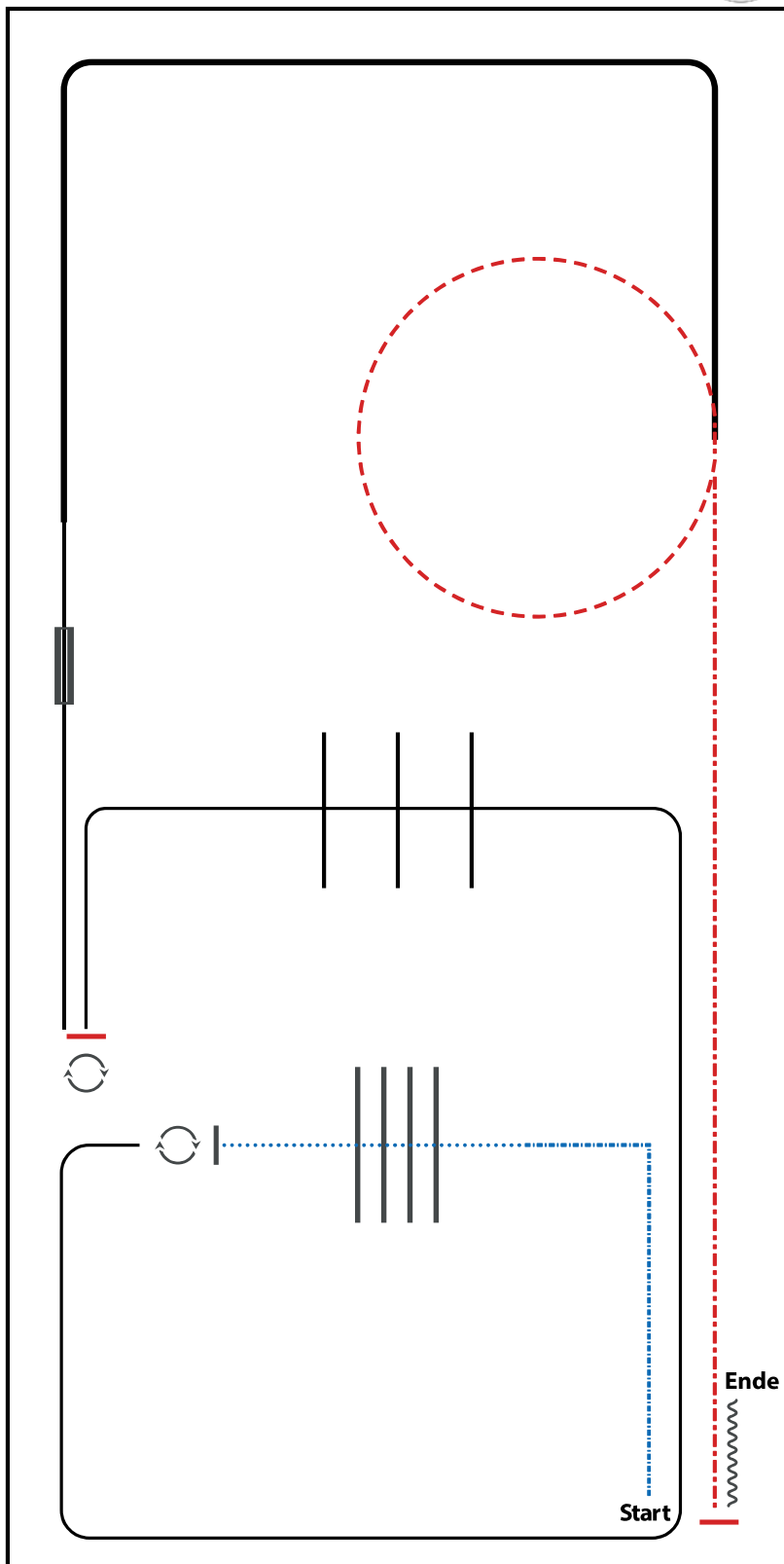

- 1) EXTENDED WALK CORNER
- 2) WALK OVER, WALK
- 3) STOP, 360° TURN LEFT
- 4) LOPE (LL), LOPE OVER
- 5) STOP, 180° TURN RIGHT
- 6) LOPE (LL), CHANGE LEADS (SIMPLE OR FLYING)
- 7) LOPE (RL), EXTENDED LOPE (RL)
- 8) TROT, SMALL CIRCLE
- 9) EXTENDED TROT
- 10) STOP, BACK UP

WALK (SCHRITT)	
EXTENDED WALK	
JOG/TROT (TRAB)	
EXTENDED TROT	
LOPE (GALOPP)	
EXTENDED LOPE	
BACK UP (RÜCKWÄRTS)	
LEAD CHANGE (GALOPPWECHSEL)	
TURN (DREHUNG)	



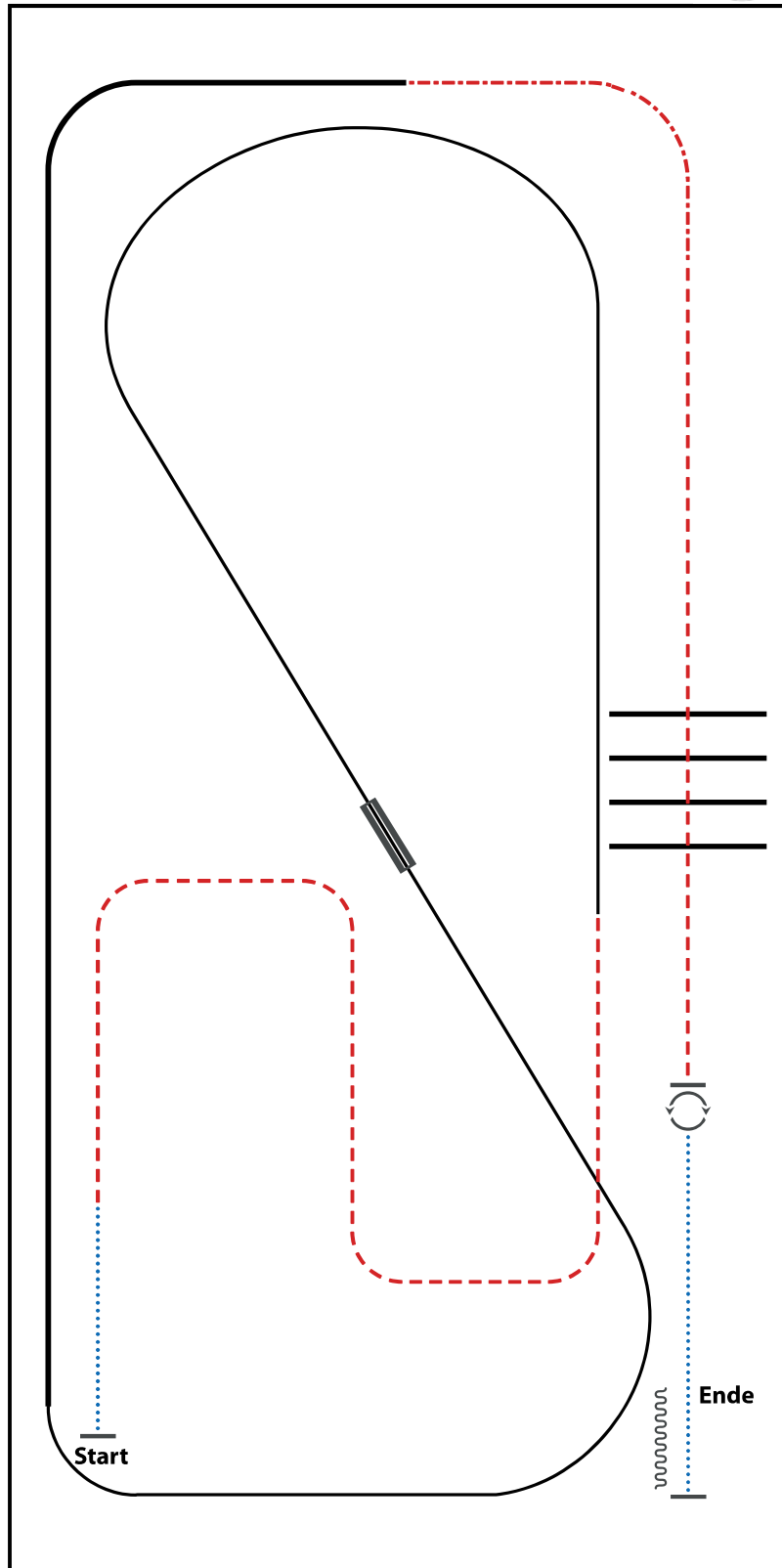

- 1) WALK
- 2) TROT
- 3) LOPE (LL)
- 4) CHANGE LEADS (SIMPLE OR FLYING)
- 5) LOPE (RL)
- 6) EXTENDED LOPE (RL)
- 7) EXTENDED TROT
- 8) TROT
- 9) TROT OVER
- 10) STOP, TURNS 360° (EACH DIRECTION)
- 11) WALK, STOP, BACK UP

WALK (SCHRITT)	
EXTENDED WALK	
JOG/TROT (TRAB)	
EXTENDED TROT	
LOPE (GALOPP)	
EXTENDED LOPE	
BACK UP (RÜCKWÄRTS)	
LEAD CHANGE (GALOPPWECHSEL)	
TURN (DREHUNG)	
 ERSTE WESTERNREITER UNION	

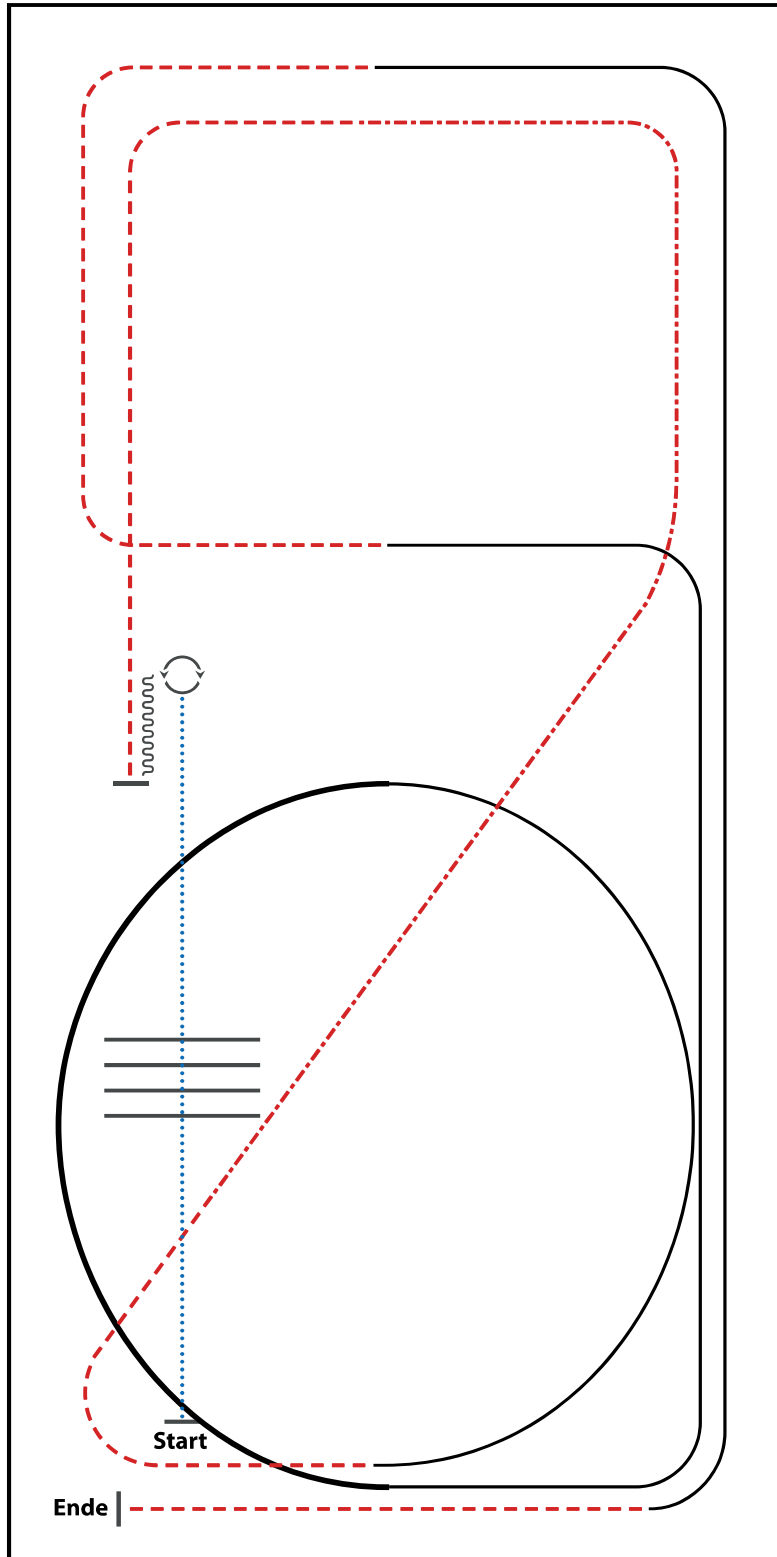

- 1) WALK
- 2) WALK OVER, WALK
- 3) STOP, TURN 360° (LEFT OR RIGHT)
- 4) BACK UP
- 5) TROT
- 6) EXTENDED TROT, TROT
- 7) LOPE (LL)
- 8) EXTENDED LOPE (LL), LOPE (LL)
- 9) TROT
- 10) LOPE (RL)
- 11) TROT, STOP

WALK (SCHRITT)	
EXTENDED WALK	
JOG/TROT (TRAB)	
EXTENDED TROT	
LOPE (GALOPP)	
EXTENDED LOPE	
BACK UP (RÜCKWÄRTS)	
LEAD CHANGE (GALOPPWECHSEL)	
TURN (DREHUNG)	
	 ERSTE WESTERNREITER UNION PFERDESPORTVERBAND WESTERPFOTEN

## Ranch Riding

## Walk Trot

Erstellt iwo  
03/2022

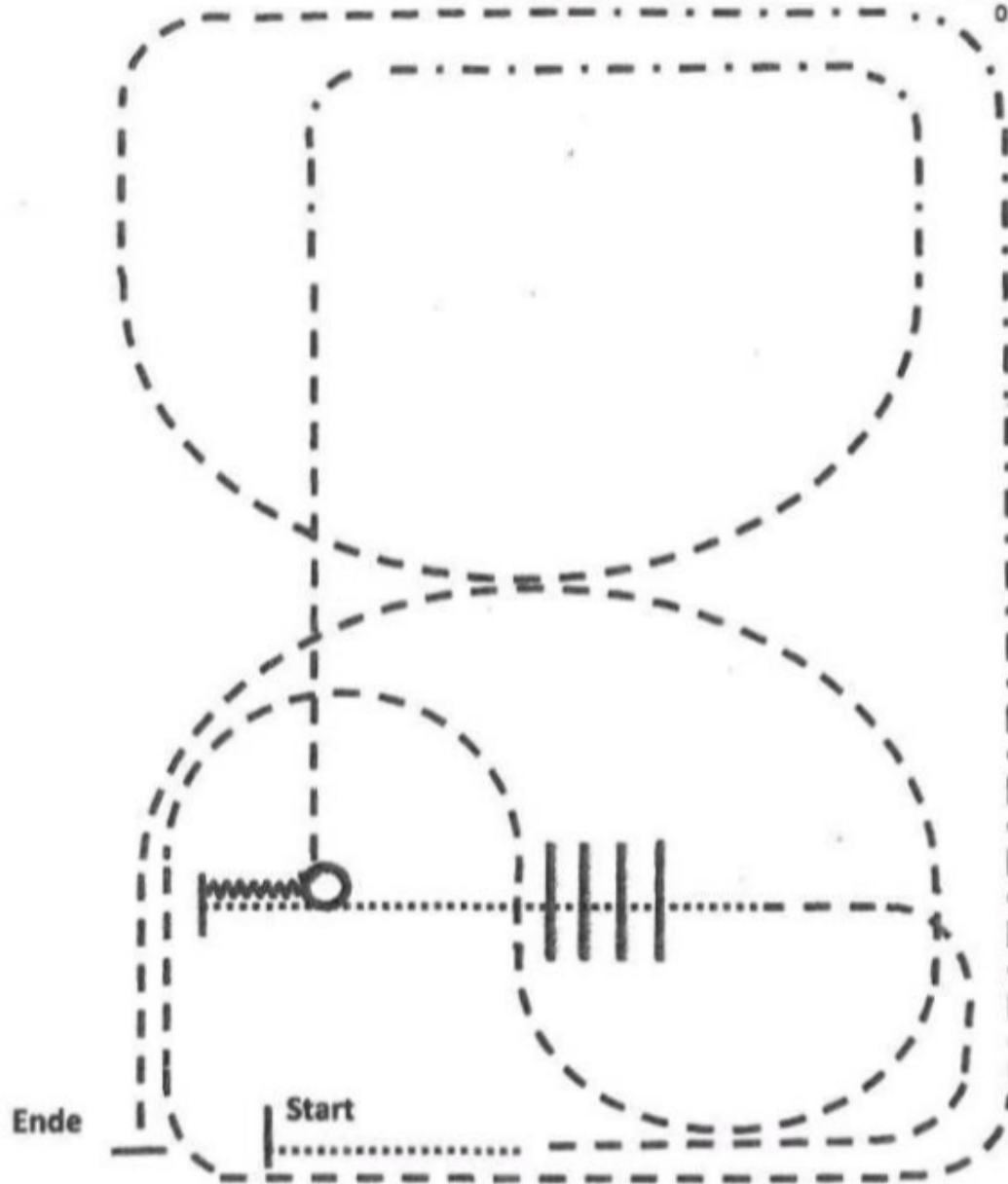

1. Walk
2. Trot
3. Walk over, Walk
4. Stop, Back up, 90° Turn rechts
5. Trot, Extended Trot
6. Trot, Extended Trot
7. Trot
8. Stop

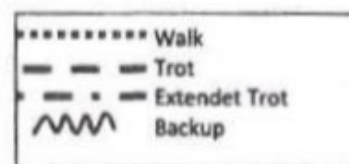



# Vielen Dank an unsere Sponsoren



Ausbildung & Coaching  
#pferdeunterstützt



ALLAROUND  
ACADEMY



AM TRATHL 17 ★ 93142 MAXHÜTTE-PIRKENSEE  
FACEBOOK.COM/DEINWESTERNSHOP  
WWW.EDITION-WESTERN-SHOP.DE

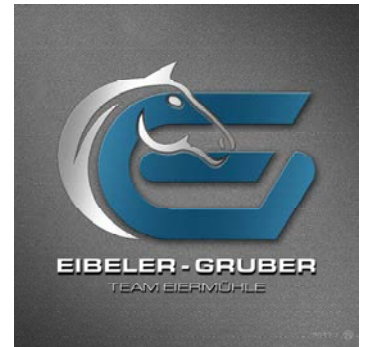

Zwaller®

EQUISPA | DOGSPA | HUMANSPA

Tiefenwärme  
Kühlung  
Moor



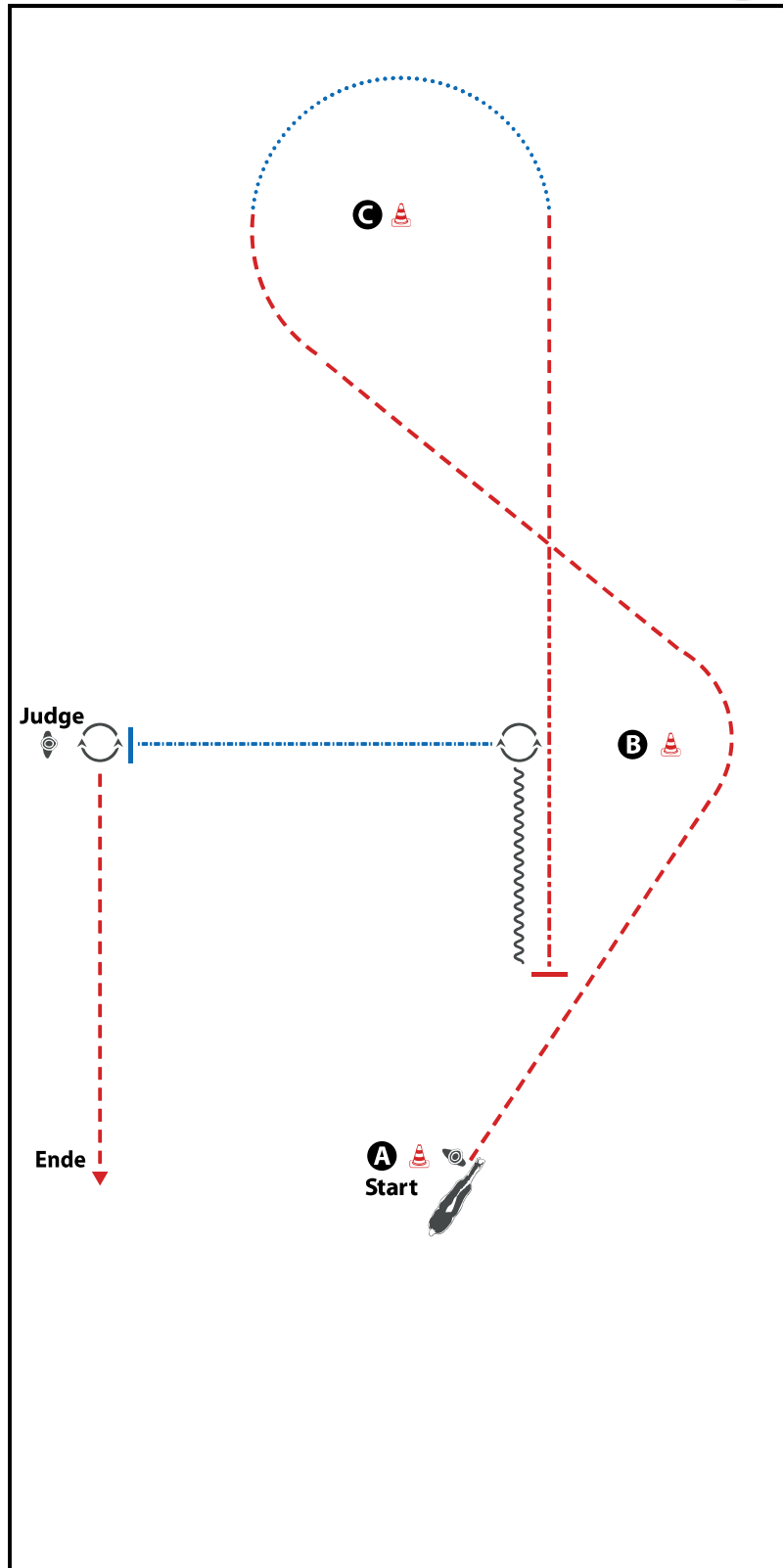

**BE READY AT MARKER**

- 1) TROT
- 2) WALK
- 3) TROT, EXTENDED TROT, STOP
- 4) BACK UP
- 5) TURN 45°
- 6) EXTENDED WALK, STOP
- 7) SET UP
- 8) INSPECTION
- 9) TURN 270°, TROT  
TROT OUT

WALK (SCHRITT)	
EXTENDED WALK	
JOG/TROT (TRAB)	
EXTENDED TROT	
LOPE (GALOPP)	
EXTENDED LOPE	
BACK UP (RÜCKWÄRTS)	
LEAD CHANGE (GALOPPWECHSEL)	
TURN (DREHUNG)	

ERSTE WESTERNREITER UNION  
 PFERDESPORTVERBAND WESTERREITEN

# Pattern Showmanship at Halter #3 - LK 3

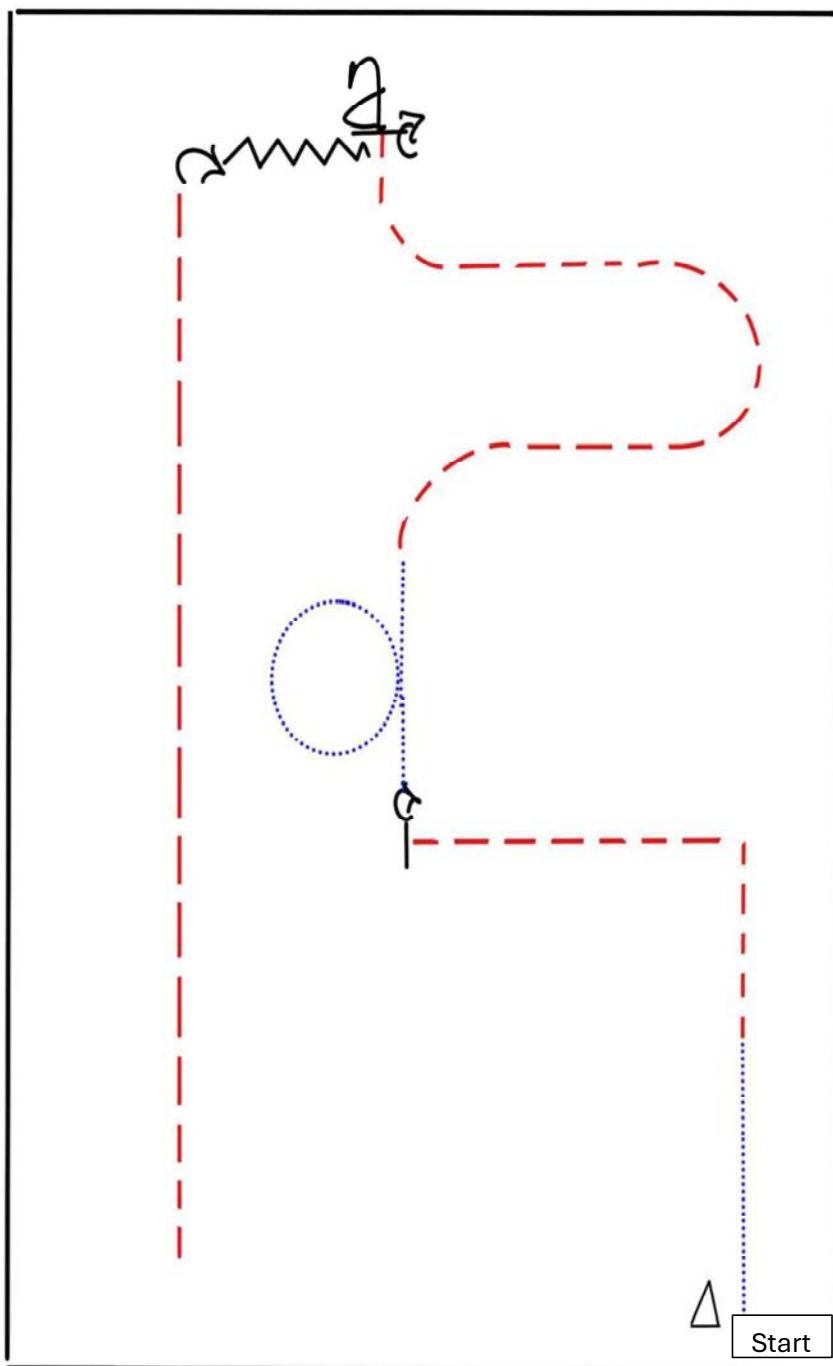

- BE READY AT MARKER
- 1) WALK
  - 2) TROT CORNER
  - 3) STOP, TURN 450°
  - 4) WALK
  - 5) TROT, STOP
  - 6) SET UP
  - 7) INSPECTION
  - 8) TURN 90°, BACK UP
  - 9) TURN 90°, TROT

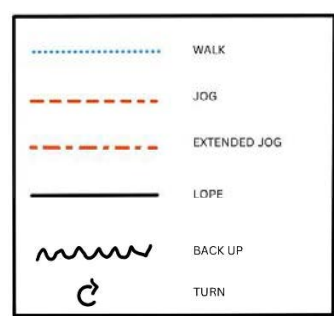

# Pattern Showmanship at Halter #1 - LK 4-5

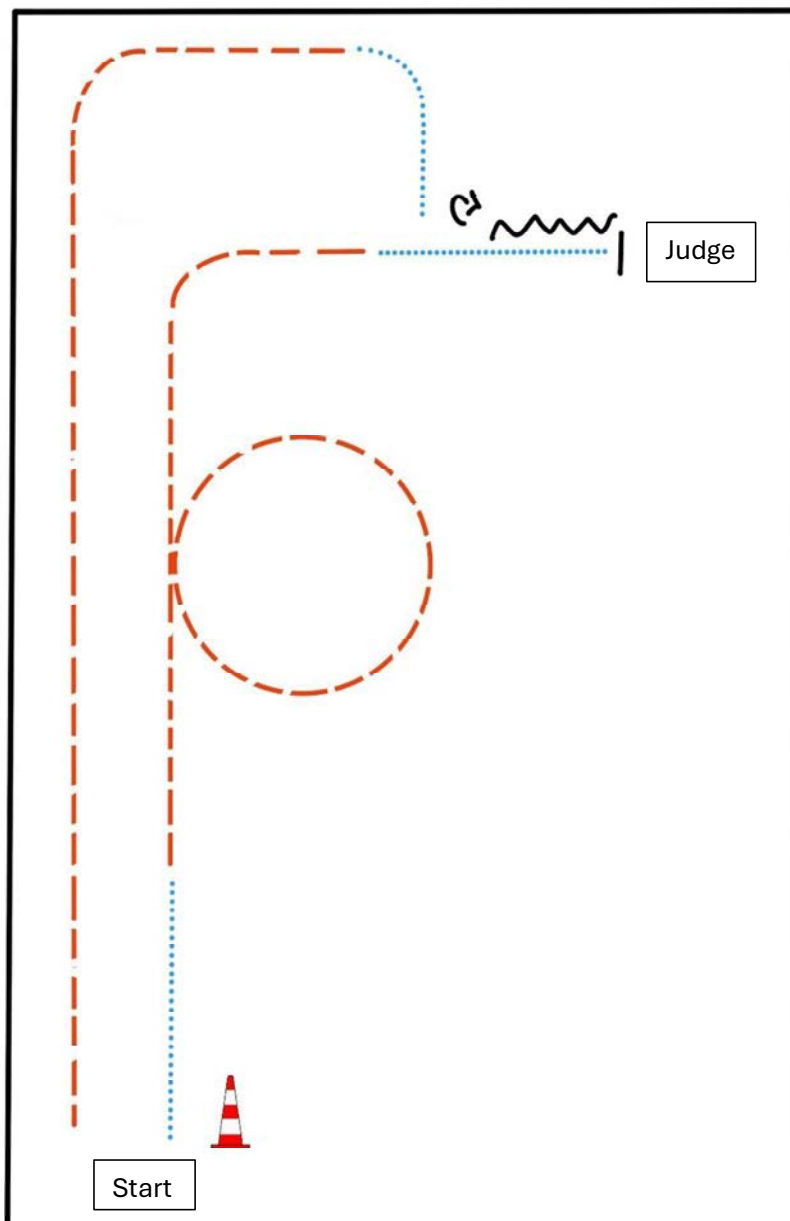

- BE READY AT MARKER
- 1) WALK
  - 2) TROT
  - 3) WALK, STOP
  - 4) SET UP
  - 5) INSPECTION
  - 6) BACK UP
  - 7) TURN 270°
  - 8) WALK, TROT
  - 9)

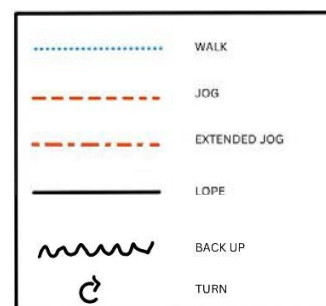



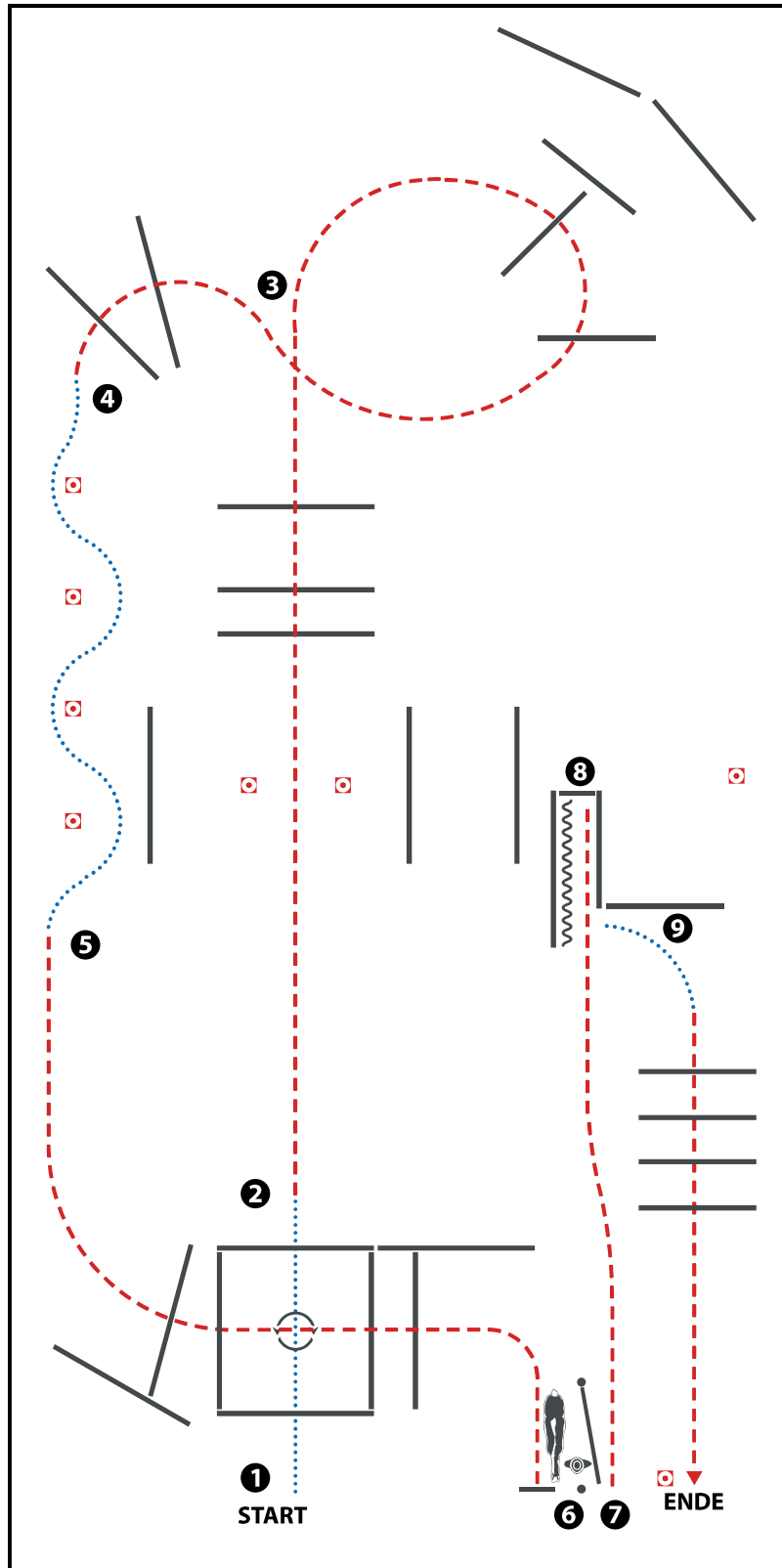

- 1) WALK INTO BOX, 360° TURN RIGHT WALK OUT
- 2) JOG OVER
- 3) JOG OVER
- 4) WALK SERPENTINE
- 5) JOG OVER
- 6) GATE LH
- 7) JOG INTO CHUTE
- 8) BACK UP, TURN RIGHT
- 9) WALK, JOG OVER

WALK (SCHRITT)	
EXTENDED WALK	
JOG/TROT (TRAB)	
EXTENDED TROT	
LOPE (GALOPP)	
EXTENDED LOPE	
BACK UP (RÜCKWÄRTS)	
LEAD CHANGE (GALOPPWECHSEL)	
TURN (DREHUNG)	

ERSTE WESTERNREITER UNION FÖRDERBUND WESTERREITEN

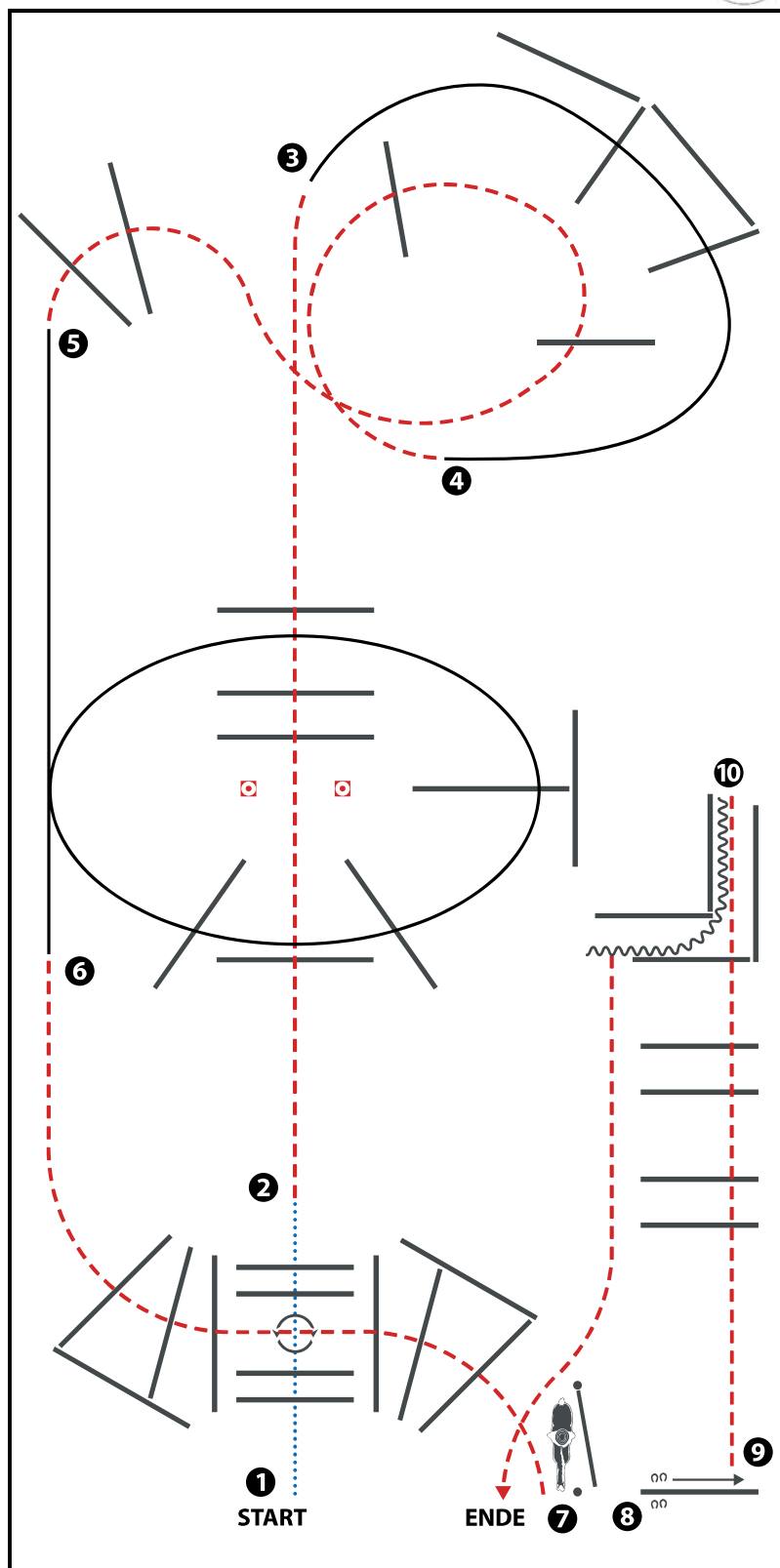

(Erhöhungen optional)

- 1) WALK OVER INTO BOX,  
360° TURN (LEFT OR RIGHT), WALK OUT
- 2) JOG OVER
- 3) LOPE OVER (RL)
- 4) JOG OVER
- 5) LOPE OVER (LL)
- 6) JOG OVER
- 7) GATE LH
- 8) SIDEPASS RIGHT
- 9) JOG OVER POLES AND INTO CHUTE
- 10) BACK UP, 90° TURN RIGHT, JOG OUT

WALK (SCHRITT)	.....
EXTENDED WALK	.....
JOG/TROT (TRAB)	-----
EXTENDED TROT	-----
LOPE (GALOPP)	-----
EXTENDED LOPE	-----
BACK UP (RÜCKWÄRTS)	~~~~~
LEAD CHANGE (GALOPPWECHSEL)	=====
TURN (DREHUNG)	⦿
	ERSTE WESTERNREITER UNION FÜRDSCHWESTERREITER

# YOUNG PERFORMANCE TROPHY 2025

POWERED  
BY



Deutsche  
Vermögensberatung  
TOBIAS KARG



## Teilnahmebedingungen:

- Jeder Jugendliche in der Leistungsklasse B von 1-5 in der EWU Bayern ist berechtigt.
- Es muss an mindestens 3 Turnieren der EWU Bayern gestartet werden, um in die Wertung zu kommen.



## Wertungskriterium:

- Die Platzierungen werden anhand des durchschnittlichen Punktestands ermittelt. Hierbei wird die Gesamtpunktzahl durch die Anzahl der Prüfungen geteilt:
- Beispiel 1: 150 Punkte ÷ 25 Prüfungen = 6,00
- Beispiel 2: 150 Punkte ÷ 20 Prüfungen = 7,50
- Der höchste Durchschnitt gewinnt.
- Es zählt immer eine Pferd/Reiter Kombination
- Highpoint Disziplin ist "Ranch Riding" - hier zählen die Punkte doppelt!



## Was gibt es zu gewinnen?:

Jede Leistungsklasse B von 1-5 werden separat in ihrer LK prämiert von Platz 1-3:

- 1. Platz: 3 Freistarts\* + Trophy
- 2. Platz: 2 Freistarts\*
- 3. Platz: 1 Freistart\*

\*Überreicht werden die Preise auf der Jahreshauptversammlung der EWU Bayern im Jahr 2026. Die Freistarts sind in der Turniersaison 2026 auf den Turnieren der EWU Bayern einlösbar. Ausgenommen sind Qualistarts auf der Double Show in Kreuth. Keine Barauszahlung möglich! Der Rechtsweg ist ausgeschlossen!



☎ 0152 27 05 46 56

✉ tobias.karg@dvag.de

SCAN  
ME



www.tobias-karg.dvag



tobiaskarg\_finanzcoaching





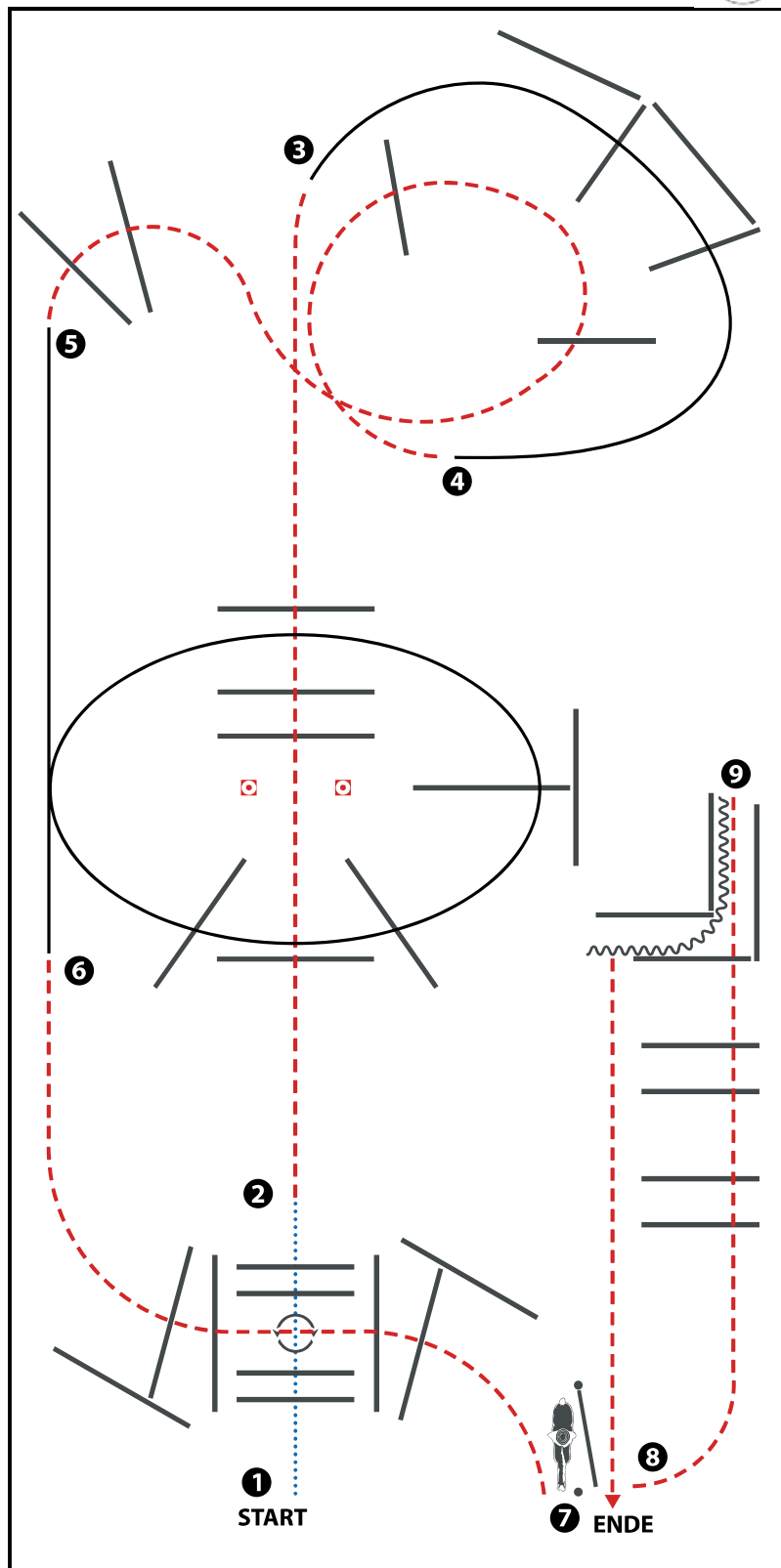





Scan den QR-Code und sichere dir dein Gespräch - unverbindlich und kostenlos!

Nutze dein volles Potential - nicht nur im Sattel! Mehr erreichen - im Reitsport & bei deinen Finanzen!



(Erhöhungen optional)

- 1) WALK OVER INTO BOX,  
360° TURN (LEFT OR RIGHT), WALK OUT
- 2) JOG OVER
- 3) LOPE OVER (RL)
- 4) JOG OVER
- 5) LOPE OVER (LL)
- 6) JOG OVER
- 7) GATE LH
- 8) JOG OVER POLES AND INTO CHUTE
- 9) BACK UP, 90° TURN RIGHT, JOG OUT

WALK (SCHRITT)	
EXTENDED WALK	
JOG/TROT (TRAB)	
EXTENDED TROT	
LOPE (GALOPP)	
EXTENDED LOPE	
BACK UP (RÜCKWÄRTS)	
LEAD CHANGE (GALOPPWECHSEL)	
TURN (DREHUNG)	
	 ERSTE WESTERNREITER UNION PFERDESPORTVERBAND WESTERREITEN



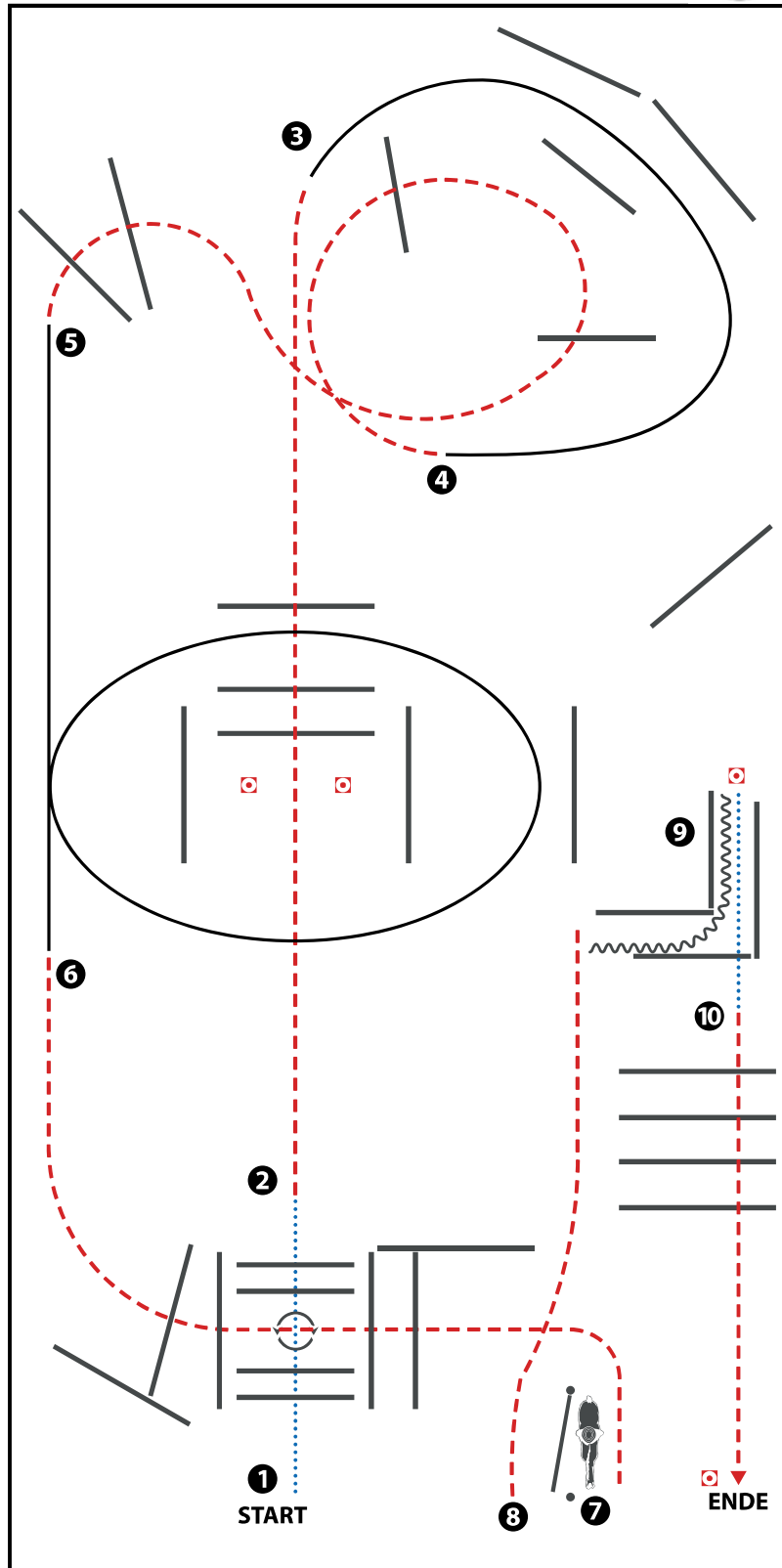

- 1) WALK OVER INTO BOX,  
360° TURN (LEFT OR RIGHT), WALK OUT
- 2) JOG OVER
- 3) LOPE (RL)
- 4) JOG OVER
- 5) LOPE (LL)
- 6) JOG OVER
- 7) GATE RH
- 8) JOG, 90° TURN LEFT
- 9) BACK UP, WALK OUT
- 10) JOG OVER

WALK (SCHRITT)	
EXTENDED WALK	
JOG/TROT (TRAB)	
EXTENDED TROT	
LOPE (GALOPP)	
EXTENDED LOPE	
BACK UP (RÜCKWÄRTS)	
LEAD CHANGE (GALOPPWECHSEL)	
TURN (DREHUNG)	

ERSTE WESTERNREITER UNION  
 FÖRDERBUND WESTERNREITEN

# Ranch Trail LK 1-3 A/B

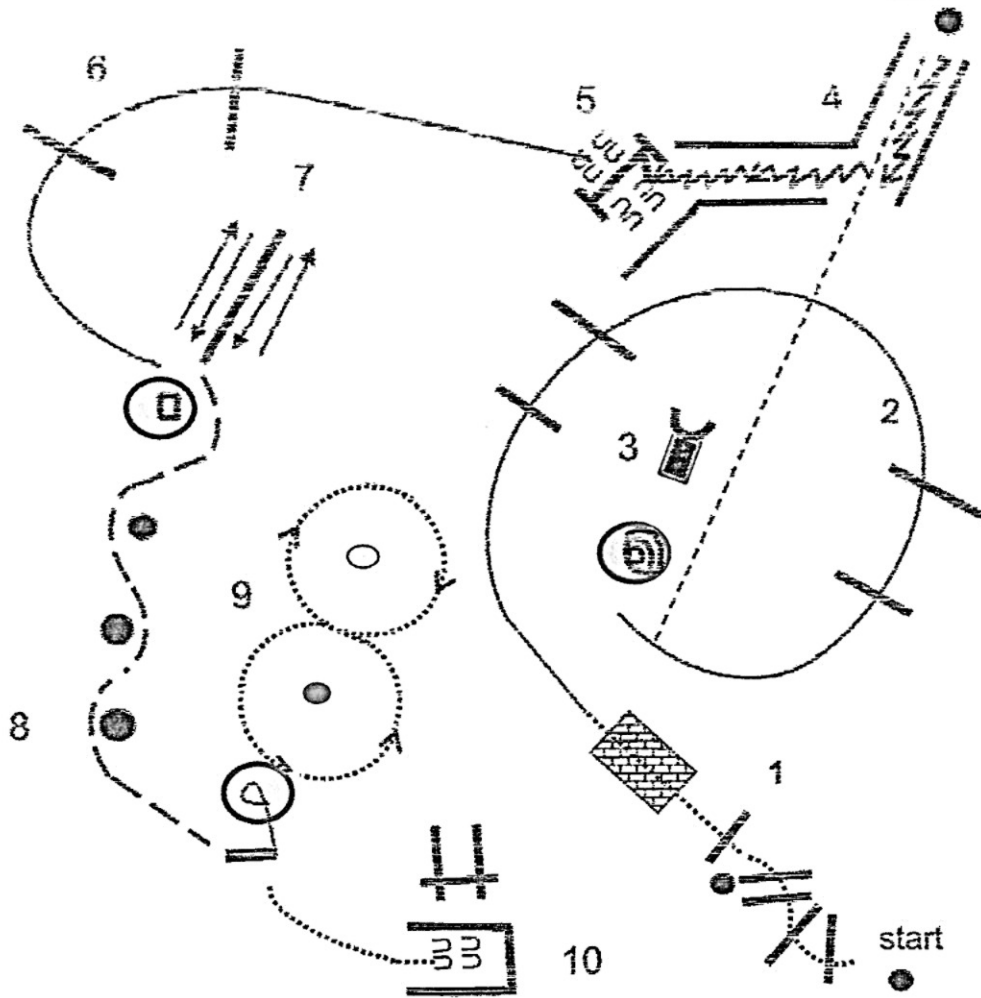

- |    |   |
|----|---|
| 1  | Walk over logs and bridge   |
| 2  | Lope right lead   |
| 3  | Rope dummy  |
| 4  | Trot - Back up  |
| 5  | work gate   |
| 6  | Lope left lead  |
| 7  | Bring the bag –side pass left and right- let it back on the support |
| 8  | Extended trot serpentine  |
| 9  | Drag log as drawn at walk or trot                                   |
| 10 | Dismount- push the log and back to horse- walk out leading horse.   |

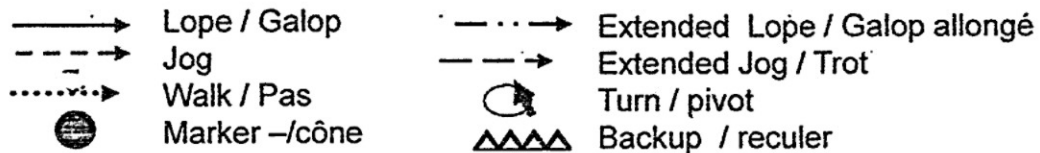

# Ranch Trail LK 4/5 A/B

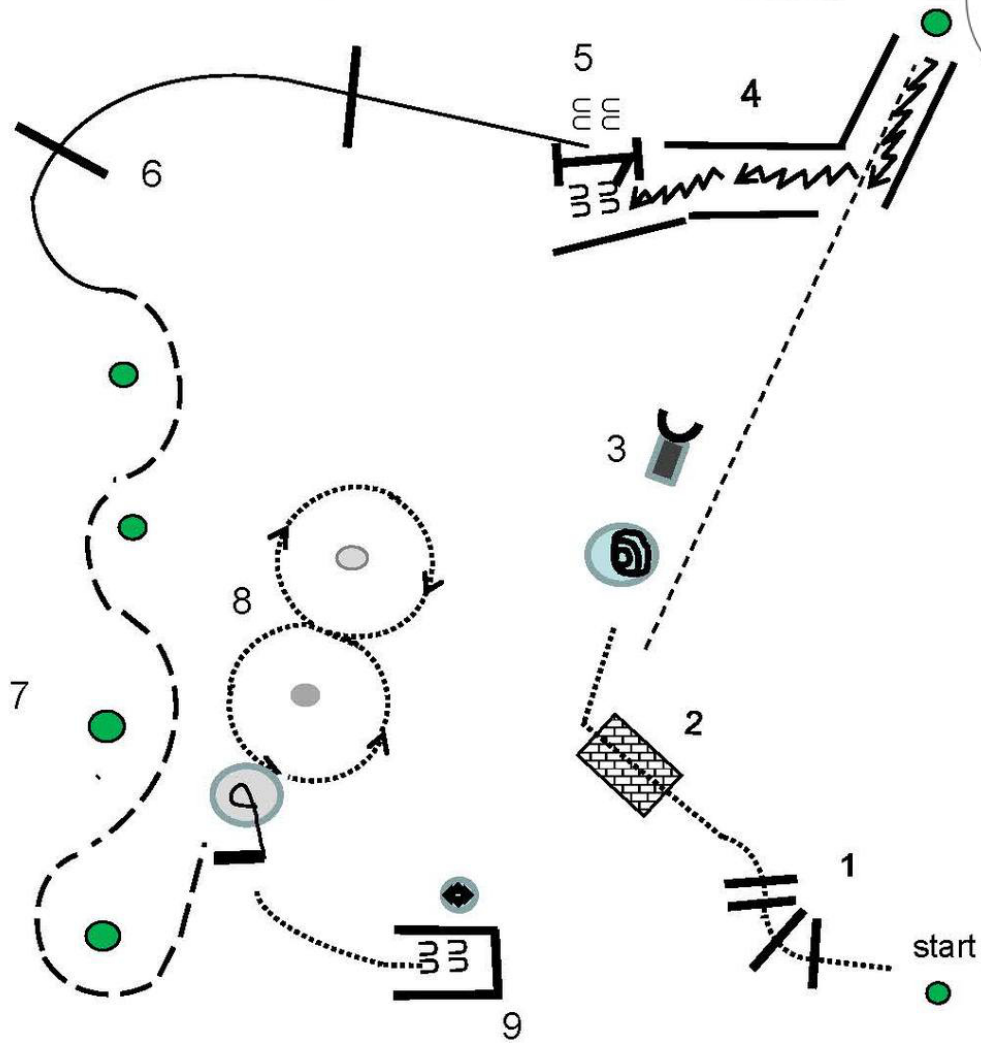





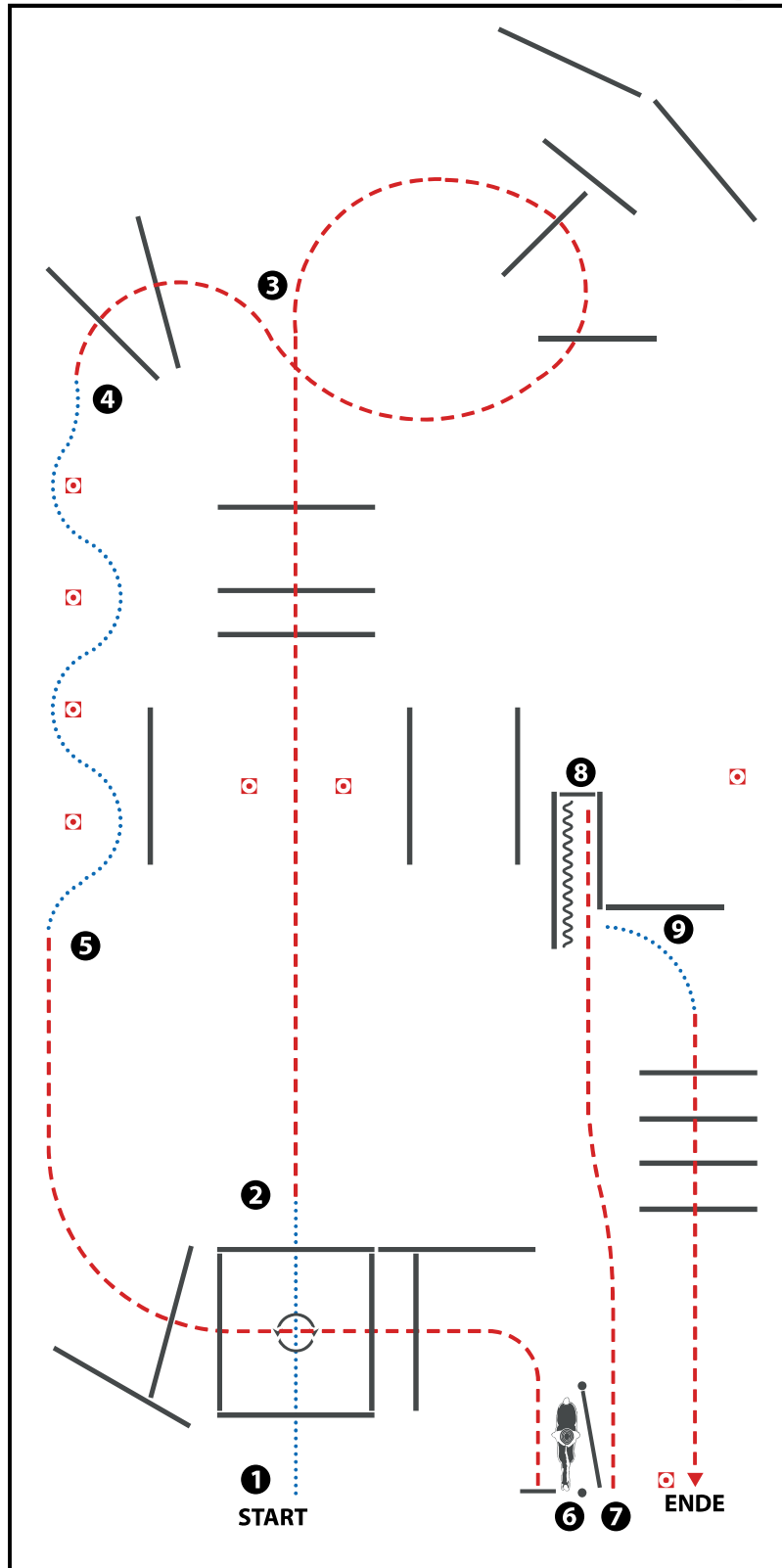





- |   |   |
|---|---|
| 1 | Walk over logs  |
| 2 | Walk over bridge  |
| 3 | Rope dummy  |
| 4 | Trot- Back up   |
| 5 | Work gate   |
| 6 | Lope left lead  |
| 7 | Extended trot serpentine  |
| 8 | Drag log as drawn at walk or trot   |
| 9 | Walk - Dismount- move the bucket and back to horse- walk out leading horse. |

- |  |               |  |                               |
|--|---------------|--|-------------------------------|
|  | Lope / Galop  |  | Extended Lope / Galop allongé |
|  | Jog           |  | Extended Jog / Trot           |
|  | Walk / Pas    |  | Turn / pivot                  |
|  | Marker -/cône |  | Backup / reculer              |



(Tor ist optional)

- 1) WALK INTO BOX, 360° TURN, WALK OUT  
(Im Schritt in die Box, eine 360° Wendung rechts oder links, im Schritt aus der Box)
- 2) JOG OVER (Trabstangen)
- 3) JOG OVER (Trabstangen)
- 4) WALK SERPENTINE (Schritt Slalom)
- 5) JOG OVER (Trabstangen)
- 6) GATE LH (Tor linke Hand)
- 7) JOG INTO CHUTE (Trab in die Gasse)
- 8) BACK UP, TURN RIGHT (Rückwärts, nach rechts abwenden)
- 9) WALK, JOG OVER (Schritt, Trabstangen)

WALK (SCHRI TT)	
EXTENDED WALK	
JOG/TROT (TRAB)	
EXTENDED TROT	
LOPE (GALOPP)	
EXTENDED LOPE	
BACK UP (RÜCKWÄRTS)	
LEAD CHANGE (GALOPPWECHSEL)	
TURN (DREHUNG)	
	 ERSTE WESTERNREITER UNION  PFERDESPORTVERBAND WESTERREICHEN



# Vielen Dank an unsere Sponsoren



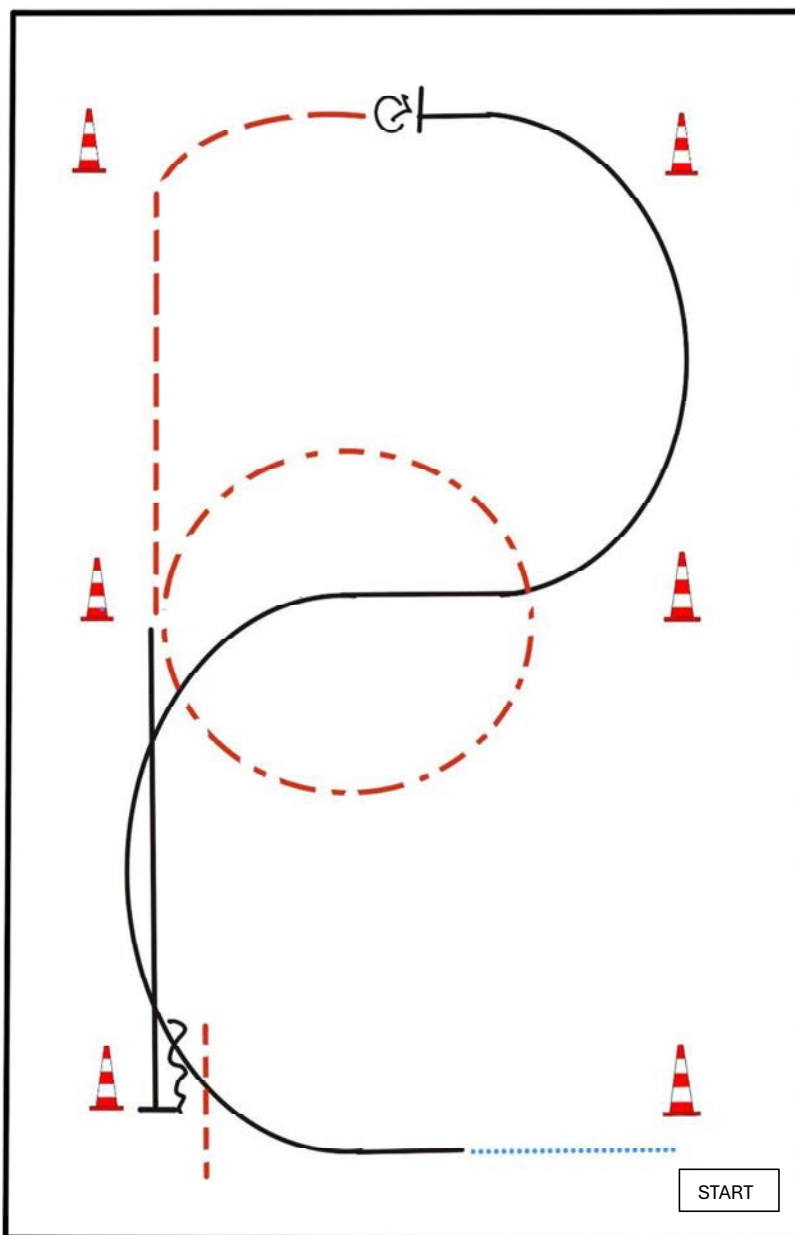

BE READY AT MARKER

- 1) WALK
  - 2) LOPE (RL)
  - 3) STOP, TURN 360° LEFT OR RIGHT
  - 4) JOG
  - 5) EXTENDED JOG CIRCLE
  - 6) LOPE (LL)
  - 7) STOP, BACK UP
- JOG OUT

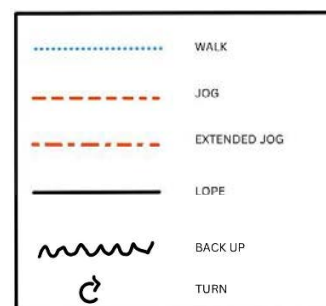

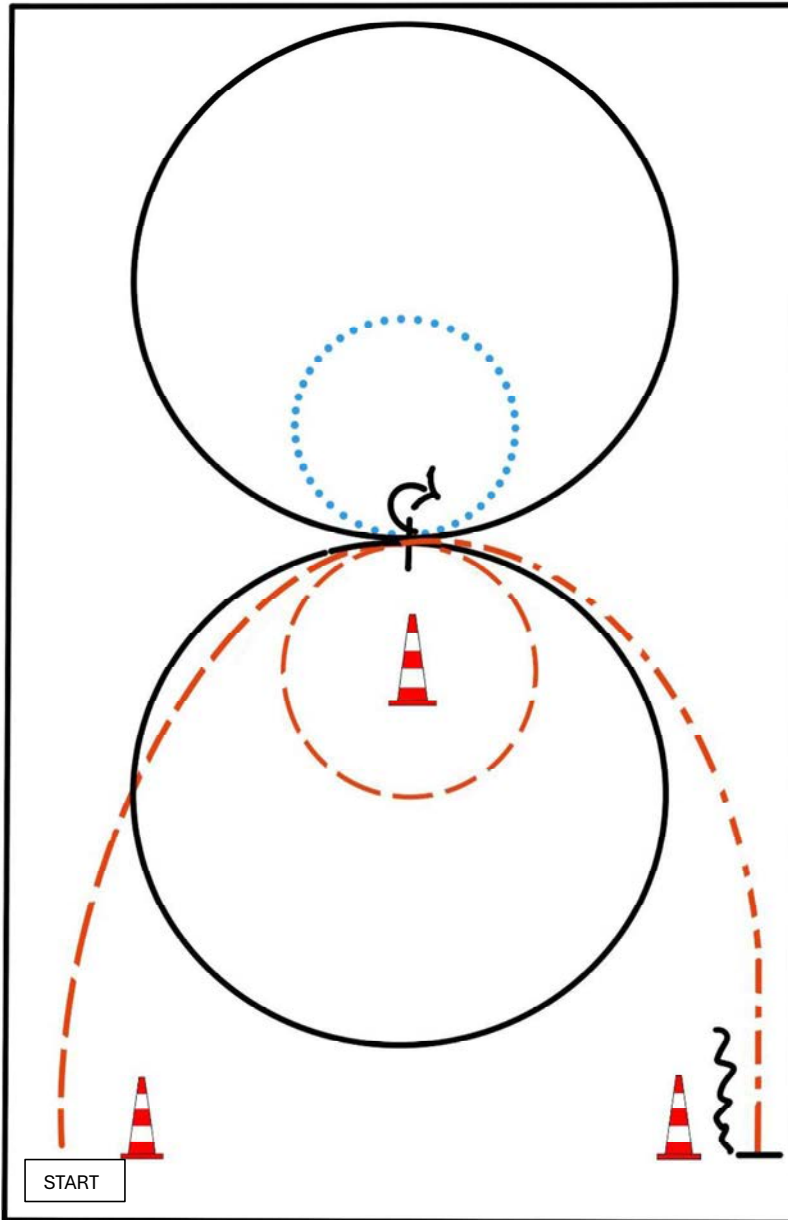





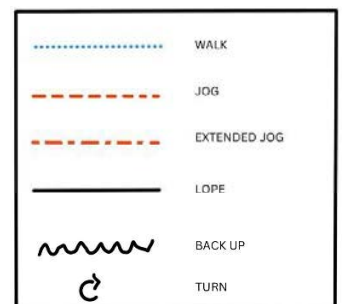

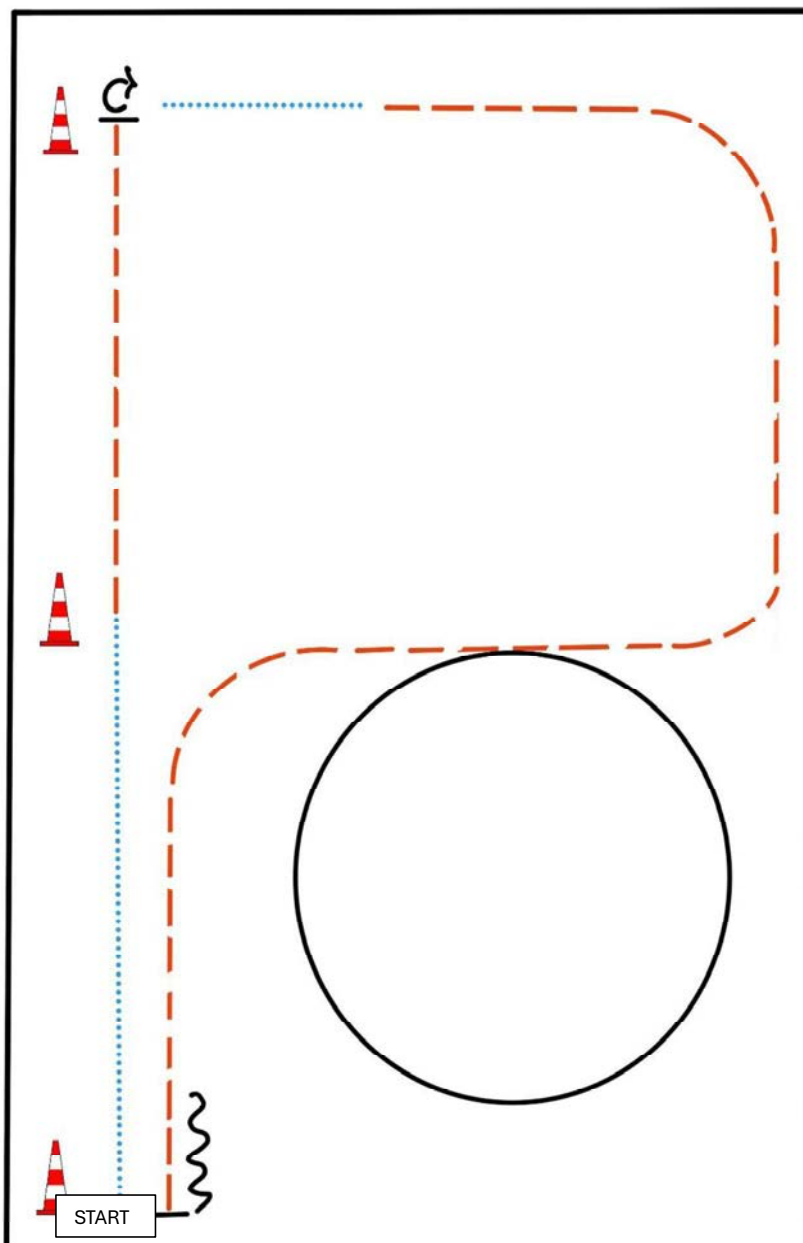
BE READY AT MARKER

- 1) JOG, STOP
- 2) TURN 360° LEFT OR RIGHT
- 3) WALK SMALL CIRCLE LEFT
- 4) LOPE (LL) CIRCLE LEFT
- 5) JOG SMALL CIRCLE RIGHT
- 6) LOPE (RL) CIRCLE RIGHT
- 7) EXTENDED JOG
- 8) STOP, BACK UP





- BE READY AT MARKER
1. WALK
  2. JOG
  3. STOP, TURN 90° RIGHT
  4. WALK
  5. JOG
  6. LOPE (LL)
  7. JOG
  8. STOP, BACK UP

	WALK
	JOG
	EXTENDED JOG
	LOPE
	BACK UP
	TURN



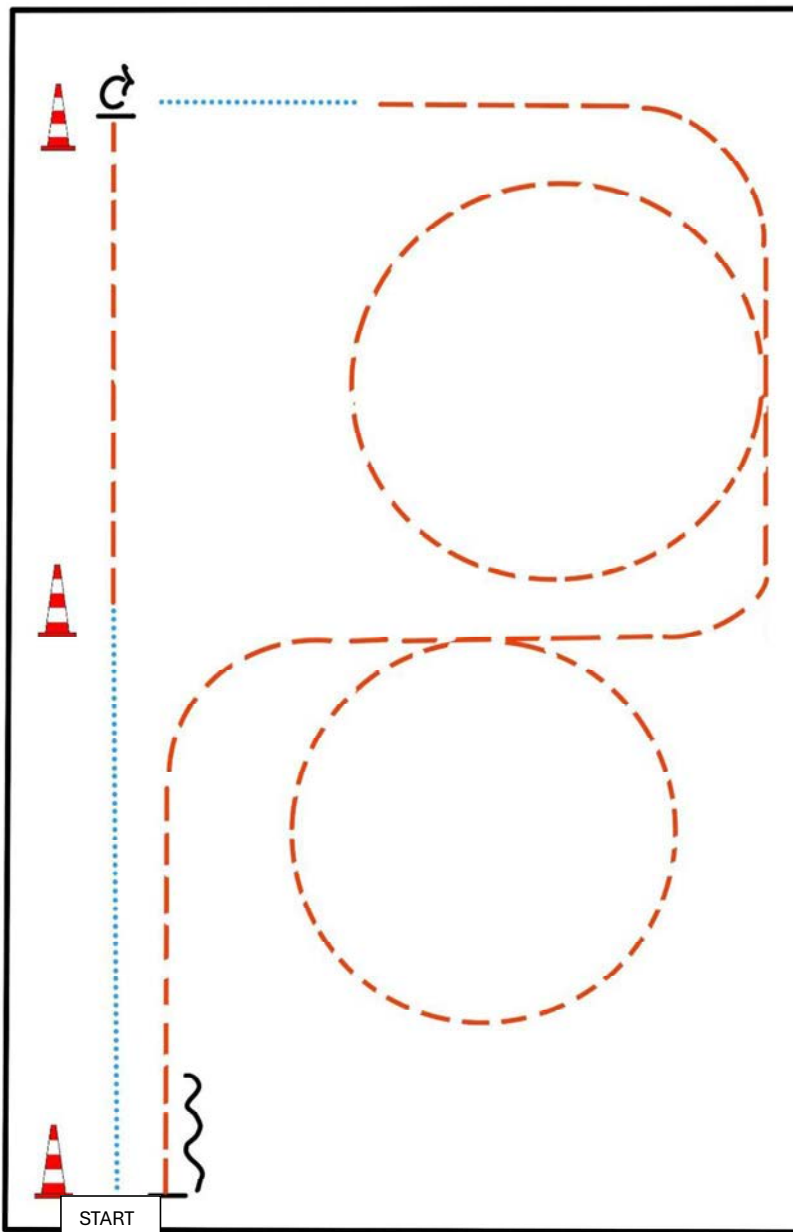

- BE READY AT MARKER
- 1) WALK
  - 2) JOG
  - 3) STOP, TURN 90° RIGHT
  - 4) WALK
  - 5) JOG, JOG SMALL CIRCLE RIGHT
  - 6) JOG, JOG SMALL CIRCLE LEFT
  - 7) JOG, STOP
  - 8) BACK UP

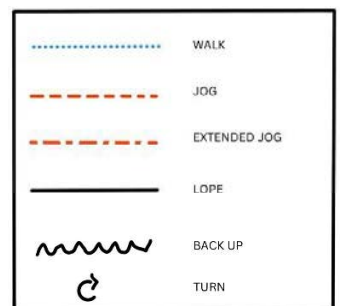

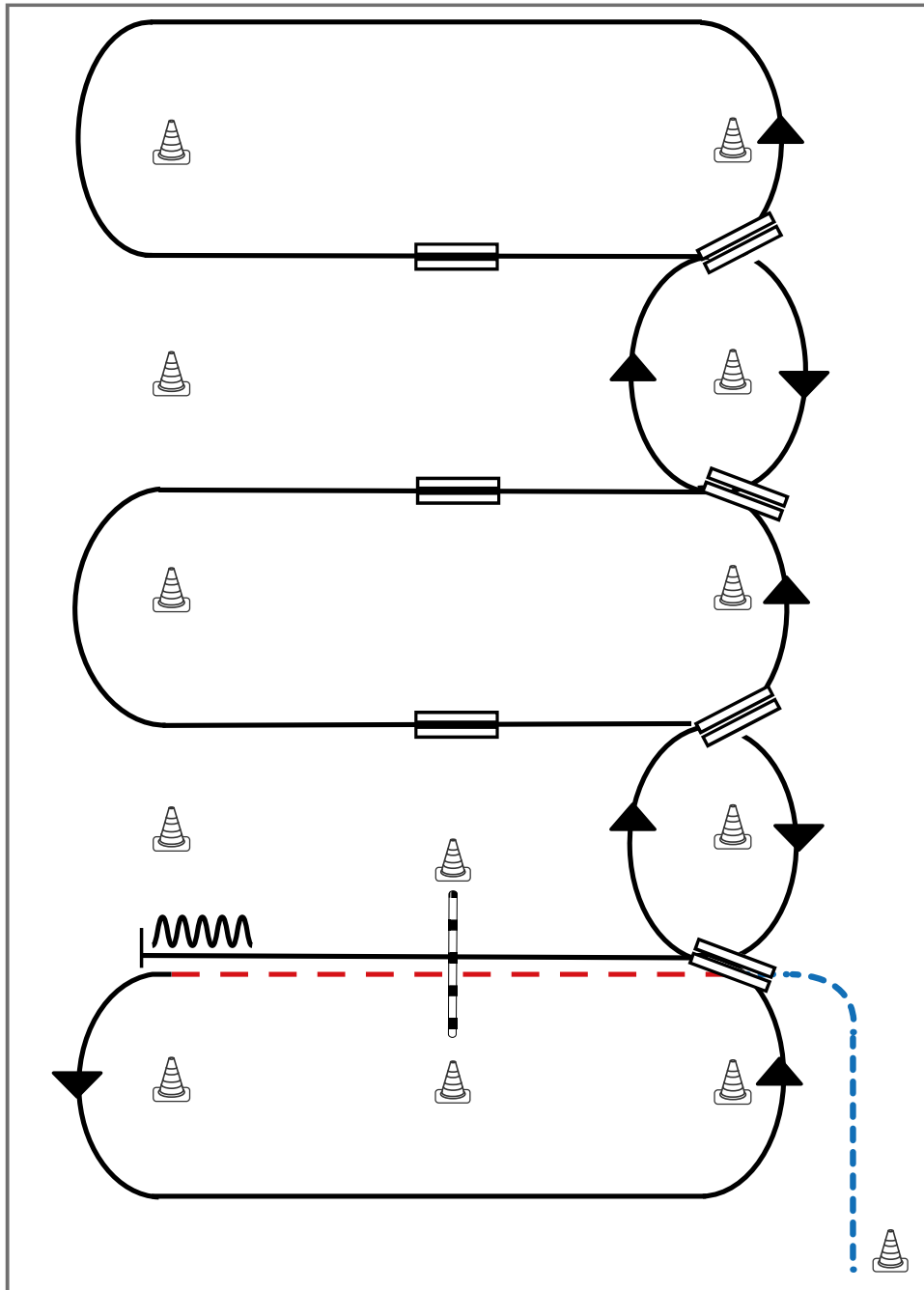

- 1) Schritt vom Start-Pylon, Übergang zum Trab zwischen den Markern, Trab über die Stange
- 2) Übergang zum Linksgalopp zwischen den Markern, Galopp an der kurzen Seite
- 3) 1. Galoppwechsel auf der Linie
- 4) 2. Galoppwechsel auf der Linie
- 5) 3. Galoppwechsel auf der Linie
- 6) 4. Galoppwechsel auf der Linie
- 7) 1. Galoppwechsel mit Seitenwechsel
- 8) 2. Galoppwechsel mit Seitenwechsel
- 9) 3. Galoppwechsel mit Seitenwechsel
- 10) Galopp über die Stange
- 11) Stop zwischen den Markern, Rückwärtsrichten

**Legende:**

Schritt	.....
Trab	— · — · — ·
Galopp	— — —
Wechselzone	▬▬▬
Rückwärts	~~~~~

EWU® Erste Westernreiter Union Deutschland e.V. | EWU WESTER REITER UNION DEUTSCHLAND e.V.

# 30 JAHRE EWU BAYERN "JUBILÄUM ZIP HOODIE"

## HERZLICHEN DANK AN UNSERE SPONSOREN

AHAA Manufaktur Bayern  
Alex Mundorff  
Allianz Agentur Julia Köhl  
DVAG Tobias Karg  
Edition Westernshop  
Eibeler-Gruber Natalie  
Gomeier World Of Saddles  
Gropper Hallen GmbH  
Gutjahr GmbH  
Hartmann Nadine  
Hummel Christine  
Horse Art Bodensee  
Mama Mia One Of A Kind  
Marstall GmbH  
Muzzolini Jasmina  
Sherwoodranch Fuchs Josef  
Western Trail  
Wild Horse Arts





30



Erste Westernreiter Union  
Bayern e.V.



JAHRE EWU BAYERN



2025

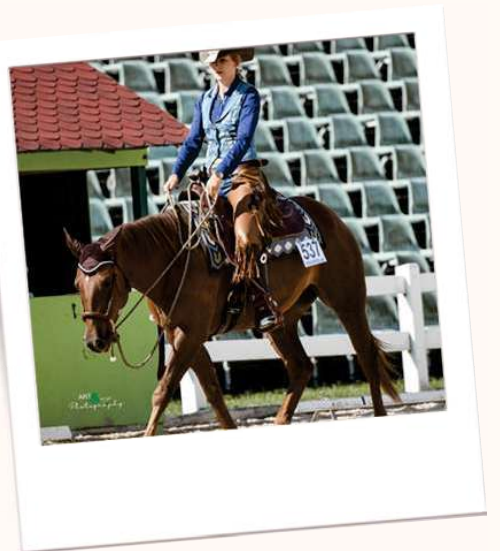

Willkommen bei  
Freunden!

[www.ewu-bayern.de](http://www.ewu-bayern.de)