

4. – 9. Juli 2023

Bavarian Summer

auf Gut Matheshof in Kreuth

Show

NSBA European Championship

4-fach AQHA-Show

NRHA (USA)-Show

NSBA-Show

VWB-Show

Golden Series Finale

50.000 Euro Preisgeld

Jungferde-Cup

3.000 Euro Preisgeld

65.000 Euro Gesamtpreisgeld

Nähere Infos unter

www.westernreiten-online.de

Veranstalter: Vereinigung der Westernreiter in Bayern e.V.



Westernreiten

ART & Soul
Photography

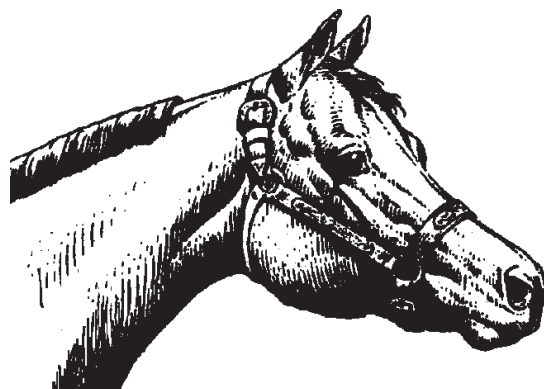

PATTERNBOOK

Bavarian Summer Show

4.-9. Juli

Bavarian Golden Series Finals
NRHA (USA)-Show
NSBA-European Championship
VWB Kat I-Show
4-fach AQHA-Show

Aktuelle Show-Infos unter westernreiten-online.de

AMERICAN
QUARTER
HORSE
ASSOCIATION

NRHA



Patternübersicht

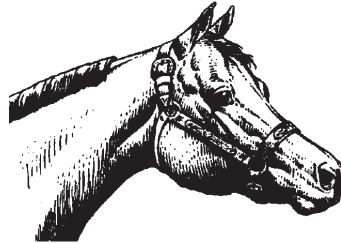

Reining

8347	VWB	Novice Jugend Reining	VWB-Pattern	8
8348	VWB	Jugend Reining	VWB-Pattern	6
9340	VWB	Einsteiger Reining	VWB-Pattern	11
7340	VWB	Amateur / Amateur Select Reining	VWB-Pattern	6
6340	VWB	Offen Reining	VWB-Pattern	2
5055	VWB	Bavarian Golden Series Reining	VWB-Pattern	9
1341	AQHA	Open Junior Reining	AQHA-Pattern	14
1342	AQHA	Open Senior Reining	AQHA-Pattern	7
1347	AQHA	Open Green Reining	AQHA-Pattern	6
2340	AQHA	Amateur Reining	AQHA-Pattern	12
3340	AQHA	Novice Amateur Reining	AQHA-Pattern	11
4340	AQHA	Youth Reining	AQHA-Pattern	15
1100	NRHA	Open Trophy	NRHA-Pattern	15
1700	NRHA	Novice Horse Open Level 1	NRHA-Pattern	6
1400	NRHA	Non Pro Trophy	NRHA-Pattern	8
1500	NRHA	Intermediate Non Pro	NRHA-Pattern	14
3200	NRHA	Youth 14-18	NRHA-Pattern	5
3100	NRHA	Youth 0-13	NRHA-Pattern	6

Western Riding

6360	VWB	Offen Western Riding	VWB-Pattern	6
7360	VWB	Amateur Western Riding	VWB-Pattern	6
9360	VWB	Einsteiger Western Riding	VWB-Pattern	8
5057	VWB	Bavarian Golden Series Western Riding	VWB-Pattern	9
1360	AQHA	Open Western Riding	AQHA-Pattern	4
1363	AQHA	Green Western Riding	Green-Pattern	L1-4
2360	AQHA	Amateur Western Riding	AQHA-Pattern	7
3360	AQHA	Novice Amateur Western Riding	AQHA-Pattern	L1-7

Ranch Riding

6430	VWB	Offen Ranch Riding	AQHA-Pattern	7
7430	VWB	Amateur Ranch Riding	AQHA-Pattern	12
9430	VWB	Einsteiger Ranch Riding	AQHA-Pattern	2
8430	VWB	Jugend Ranch Riding	AQHA-Pattern	10
1430	AQHA	Open Ranch Riding	AQHA-Pattern	8
2430	AQHA	Amateur Ranch Riding	AQHA-Pattern	3
5054	VWB	Bavarian Golden Series Ranch Riding	Seite	20

Patternübersicht



Jungpferde

6840	VWB	Jungpferde-Reining	VWB-Pattern	2
6880	VWB	Jungpferde-Trail	VWB-Pattern	2
6890	VWB	Jungpferde-Basis	VWB-Pattern	2

Western Combination

6600	VWB	Western Combination Open	VWB-Pattern	2
------	-----	--------------------------	-------------	---

Trail

1381	AQHA	Open Junior Trail	Seite	8
1382	AQHA	Open Senior Trail	Seite	7
1383	AQHA	Green Trail	Seite	6
2380	AQHA	Amateur Trail	Seite	7
2388	AQHA	Amateur Select Trail	Seite	7
3380	AQHA	Novice Amateur Trail	Seite	6
4380	AQHA	Youth Trail	Seite	6
5006	NSBA	Open Trail in Hand	Seite	8
6380	VWB	Offen Trail	Seite	8
6390	VWB	Offen Ranch Trail	Seite	9
6830	VWB	Offen Trail in Hand	Seite	9
7380	VWB	Amateur Trail	Seite	11
7390	VWB	Amateur Ranch Trail	Seite	12
9380	VWB	Einsteiger Trail	Seite	12
8387	VWB	Novice Jugend	Seite	11
8388	VWB	Jugend	Seite	11
5050	VWB	Bavarian Golden Series Trail	Seite	10
5056	VWB	Bavarian Limited Series Trail	Seite	10

Showmanship

	VWB	alle Showmanship VWB	Seite	14 / 15
	AQHA	alle Showmanship AQHA	Seite	16
6810	VWB	Jungpferde-Cup	Seite	13
5052	VWB	Bavarian Golden Series Showmanship	Seite	13

Horsemanship

	VWB	alle Horsemanship VWB	Seite	17 / 18
	AQHA	alle Horsemanship AQHA	Seite	18 / 19
5053	VWB	Bavarian Golden Series Horsemanship	Seite	20

Hunt Seat Equitation

	AQHA	alle Hunt Seat Equitation AQHA	Seite	22
--	------	--------------------------------	-------	----

WEDNESDAY 5.7.23

#4380 AQHA YOUTH

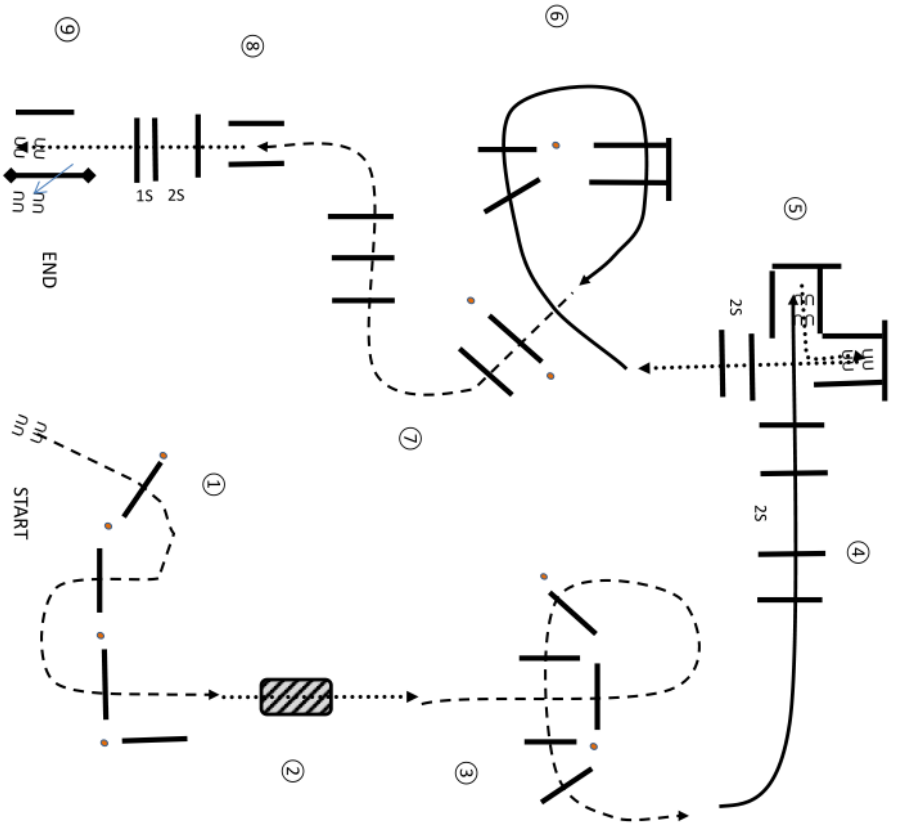

- 1 JOG SERPENTINE-STOP OR BREAK TO A WALK
- 2 BRIDGE
- 3 JOG OVERS
- 4 LL LOPE OVERS INTO CHUTE
- 5 STOP AND BACK L INTO CHUTE
- 6 RL LOPE OVERS
- 7 JOG OVERS INTO CHUTE
- 8 STOP OR BREAK TO A WALK-WALK OVERS
- 9 LH OPEN GATE RIDE THRU CLOSE

ANNDENNISDESIGN COPYRIGHT 2023
ALL RIGHTS RESERVED

WEDNESDAY 5.7.23

#1383 AQHA GREEN OPEN
#3380 AQHA NOVICE AMATEUR

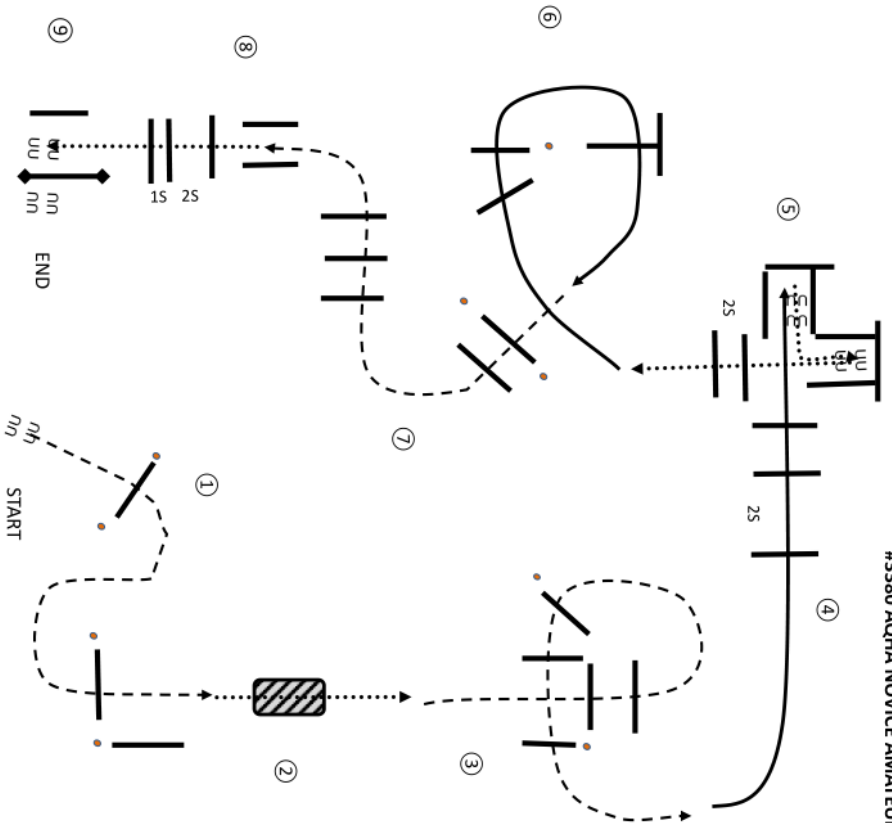

- 1 JOG SERPENTINE-STOP OR BREAK TO A WALK
- 2 BRIDGE
- 3 JOG OVERS
- 4 LL LOPE OVERS INTO CHUTE
- 5 STOP AND BACK L INTO CHUTE
- 6 RL LOPE OVERS
- 7 JOG OVERS INTO CHUTE
- 8 STOP OR BREAK TO A WALK-WALK OVERS
- 9 LH OPEN GATE RIDE THRU CLOSE

ANNDENNISDESIGN COPYRIGHT 2023
ALL RIGHTS RESERVED

THURSDAY 6.7.23

#1382 AQHA SENIOR TRAIL

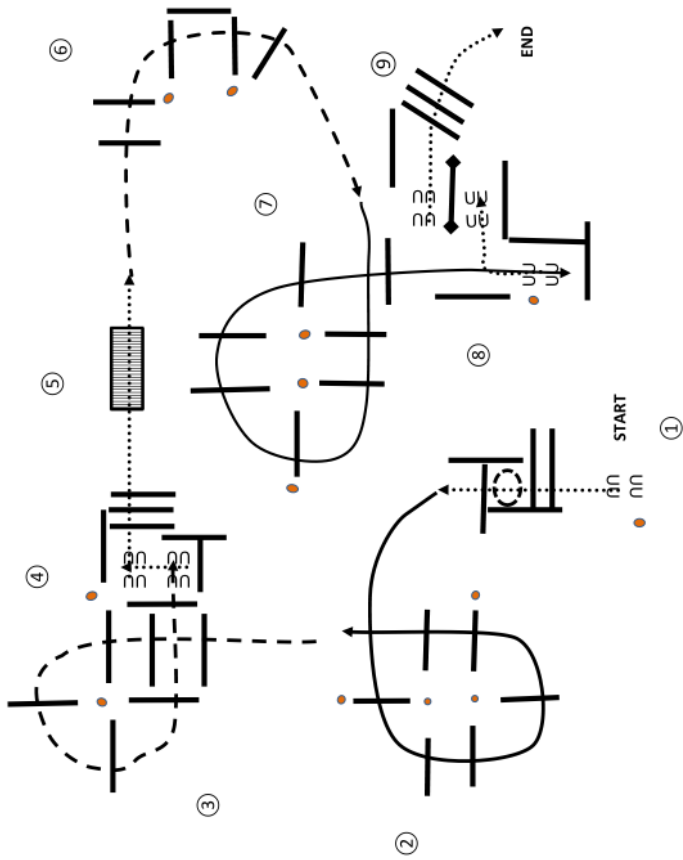

- 1 WALK OVERS INTO BOX -360 EITHER WAY-WALK OVER
- 2 LL LOPE OVERS
- 3 JOG OVERS
- 4 JOG IN STOP-SIDEPASS
- 5 WALK OVERS -BRIDGE
- 6 JOG OVERS
- 7 RL LOPE OVERS INTO CHUTE STOP
- 8 BACK L TO GATE-RH OPEN GATE WALK THROUGH CLOSE
- 9 WALK OVERS

ANNDENNISDESIGN.COPYRIGHT 2023
ALL RIGHTS RESERVED

THURSDAY 6.7.23

#2380 AQHA AMATEUR TRAIL
#2388 AQHA AMA SELECT TRAIL

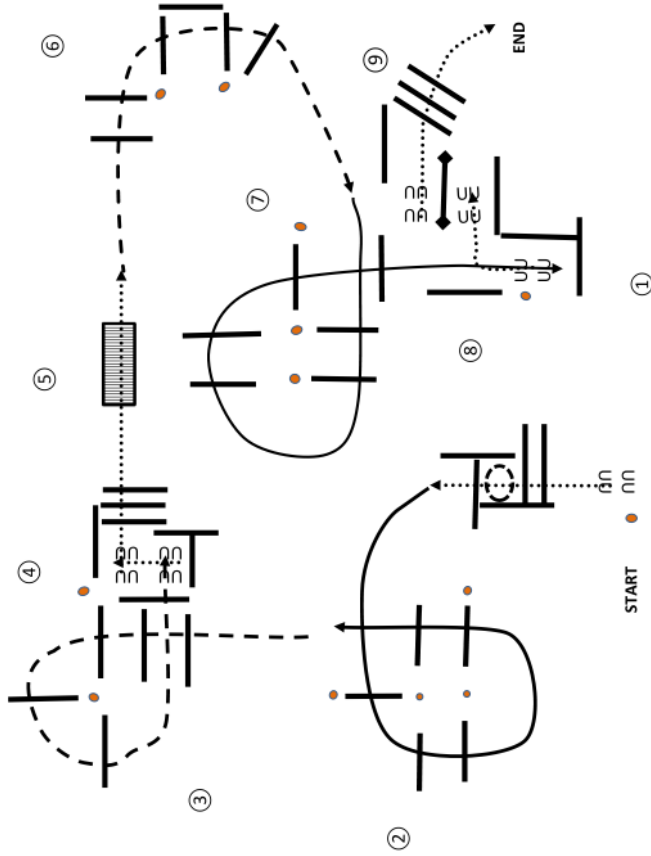

- 1 WALK OVERS INTO BOX -360 EITHER WAY-WALK OVER
- 2 LL LOPE OVERS
- 3 JOG OVERS
- 4 JOG IN STOP-SIDEPASS
- 5 WALK OVERS -BRIDGE
- 6 JOG OVERS
- 7 RL LOPE OVERS INTO CHUTE STOP
- 8 BACK L TO GATE-RH OPEN GATE WALK THROUGH CLOSE
- 9 WALK OVERS

ANNDENNISDESIGN.COPYRIGHT 2023
ALL RIGHTS RESERVED

THURSDAY 6.7.23

#1381 AQHA JUNIOR TRAIL

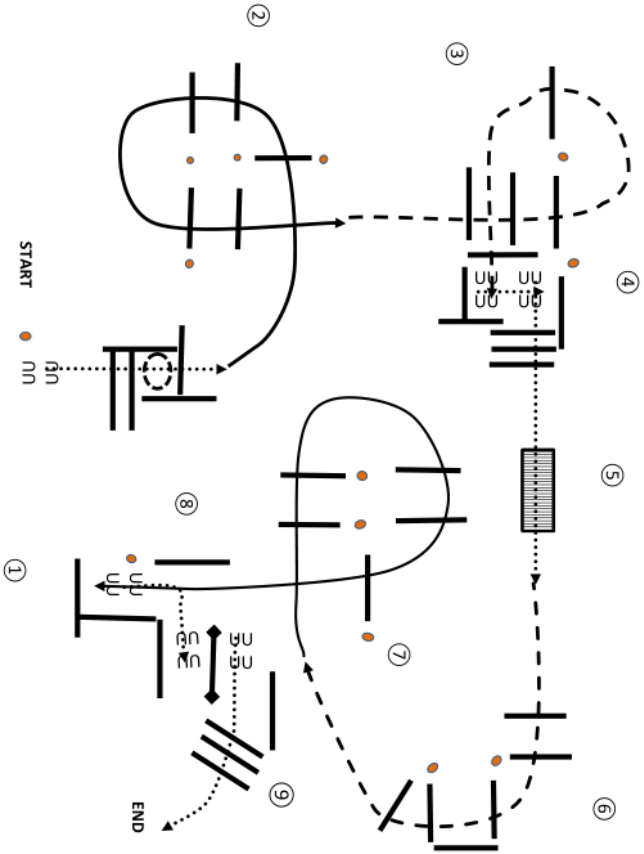

- 1 WALK OVERS INTO BOX -360 EITHER WAY-WALK OVER
- 2 LL LOPE OVERS
- 3 JOG OVERS
- 4 JOG IN STOP-SIDEPASS
- 5 WALK OVERS –BRIDGE
- 6 JOG OVERS
- 7 RL LOPE OVERS INTO CHUTE STOP
- 8 BACK L TO GATE-RH OPEN GATE WALK THROUGH CLOSE
- 9 WALK OVERS

ANNDENNISDESIGN COPYRIGHT 2023
ALL RIGHTS RESERVED

THURSDAY 6.7.23

#5006 NSBA OPEN TRAIL IN HAND

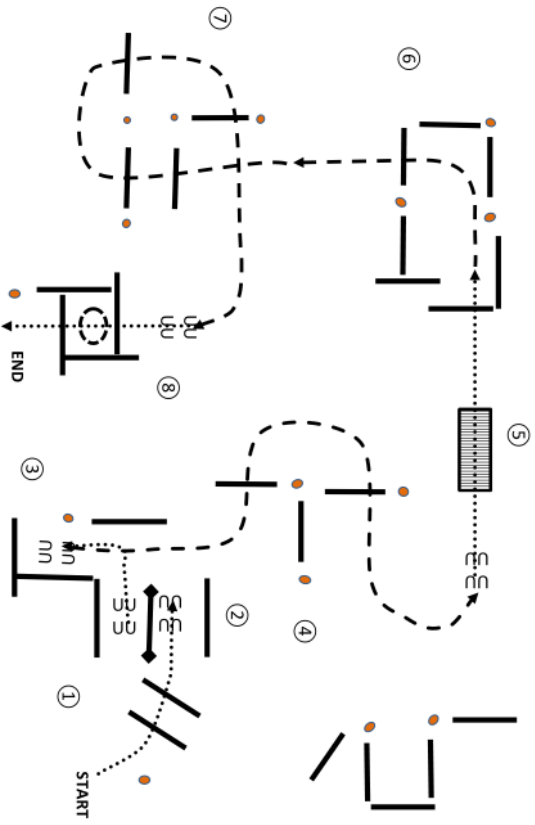

- 1 WALK OVERS TO GATE
- 2 LH GATE OPEN WALK THROUGH CLOSE
- 3 BACK OUT INTO CHUTE-TROT OUT
- 4 TROT OVERS
- 5 STOP OR BREAK TO A WALK-BRIDGE-WALK OVER POLE
- 6 TROT OVERS
- 7 TROT OVERS
- 8 STOP OR BREAK TO A WALK-WALK INTO BOX 360 RIGHT-WALK OVER

ANNDENNISDESIGN COPYRIGHT 2023
ALL RIGHTS RESERVED

FRIDAY 7.7.23

#6380 VWB TRAIL ALL AGES OFFEN

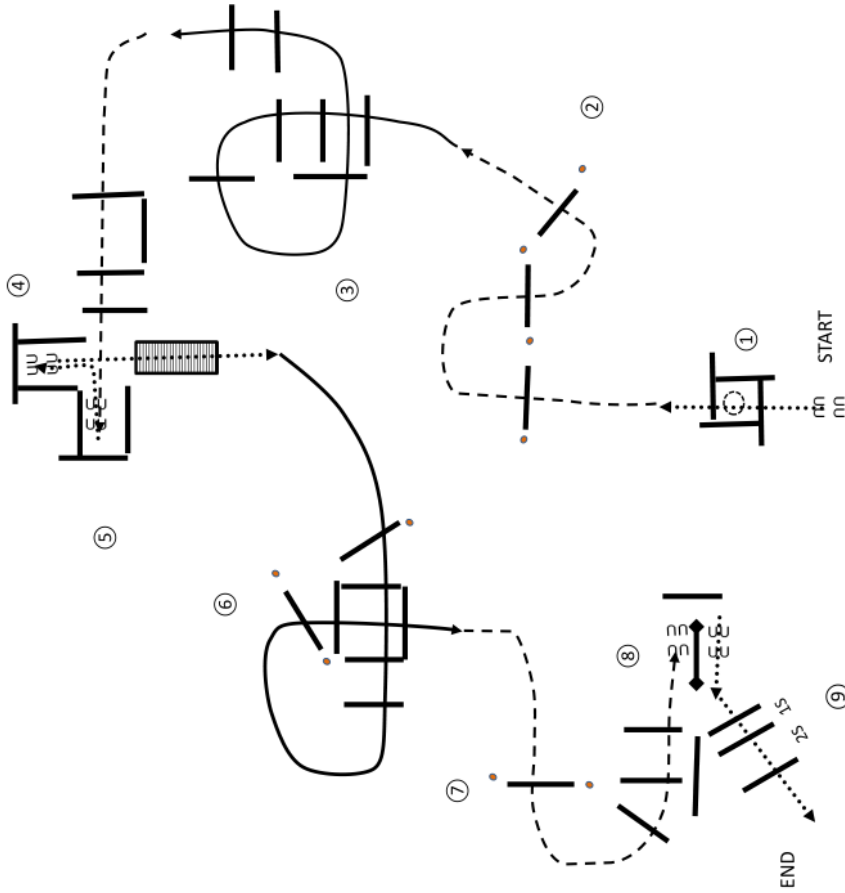

- 1 WALK OVERS INTO BOX-360 RIGHT OR LEFT-WALK OVER
- 2 JOG SERPENTINE
- 3 LL LOPE OVERS
- 4 JOG OVERS INTO CHUTE
- 5 STOP AND BACK INTO CHUTE-BRIDGE
- 6 RL LOPE OVERS
- 7 JOG OVERS-TO GATE STOP
- 8 RH OPEN GATE RIDE THRU CLOSE
- 9 WALK OVERS-END OF PATTERN

ANNDENNISDESIGN COPYRIGHT 2023
ALL RIGHTS RESERVED

FRIDAY 7.7.23

#6830 TRAIL IN HAND JUNGPFERDE-CUP

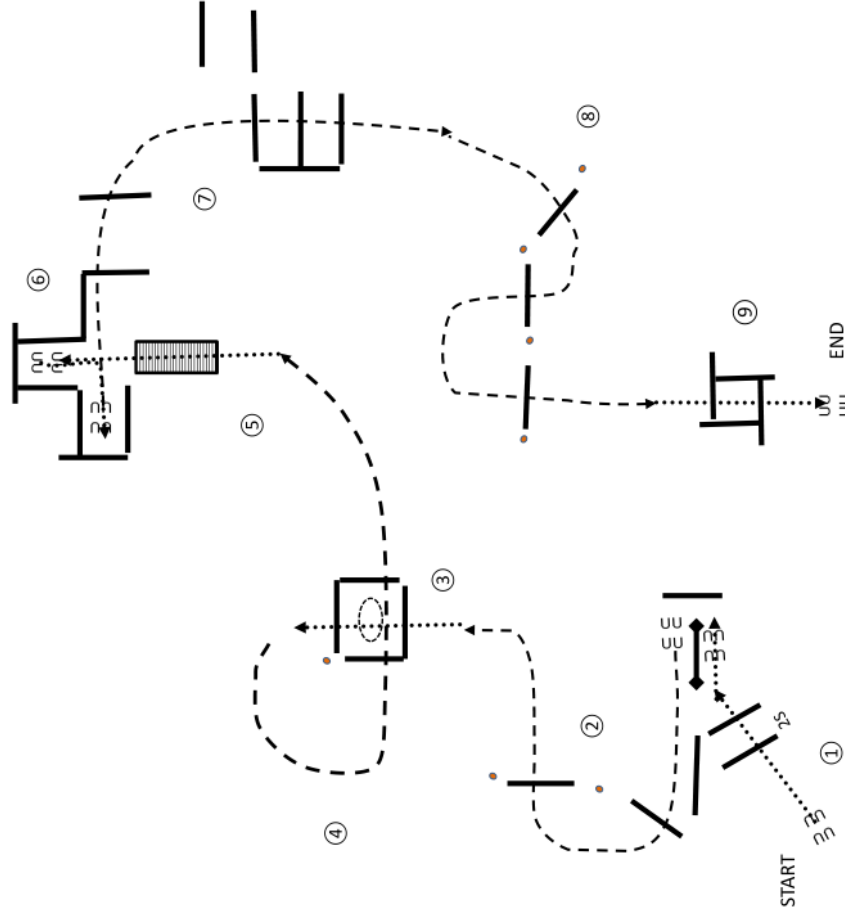

- 1 WALK OVERS TO GATE- LH GATE-OPEN WALK THROUGH CLOSE
- 2 TROT OVERS
- 3 STOP OR BREAK TO A WALK-WALK IN BOX 360 RIGHT-WALK OVER
- 4 TROT OVERS
- 5 STOP OR BREAK TO A WALK-BRIDGE-WALK INTO CHUTE
- 6 BACK L INTO CHUTE-TROT OUT
- 7 TROT OVERS
- 8 TROT SERPENTINE
- 9 STOP OR BREAK TO A WALK-WALK OVERS

ANNDENNISDESIGN COPYRIGHT 2023
ALL RIGHTS RESERVED

FRIDAY 7.7.23

#6390 VWB RANCH TRAIL OFFEN

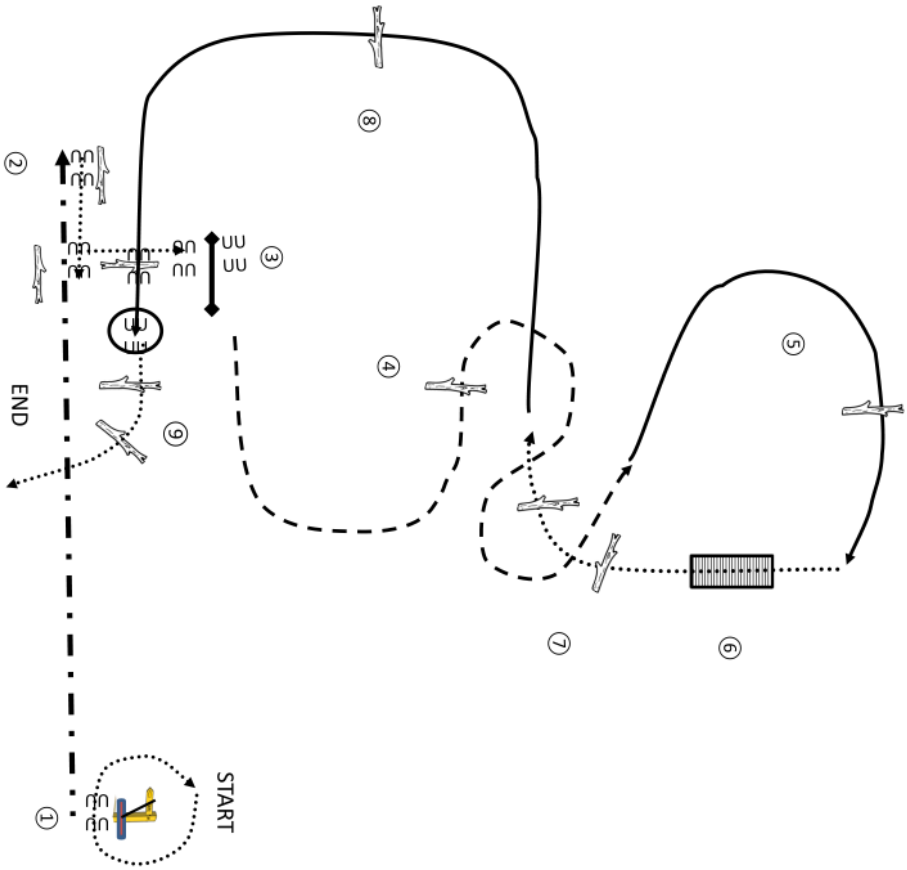

- 1 PICK UP ROPE-DAILY DRAG LOG RIGHT CIRCLE TROT OR WALK-PUT LOG BACK TO START
- 2 EXTENDED TROT PAST LOG-STOP AND BACK
- 3 SIDEPASS TO GATE-RH GATE OPEN RIDE THRU CLOSE-TROT OUT
- 4 TROT SERPENTINE OVER 1 LOG
- 5 RL LOPE OVER LOG-BREAK TO A WALK-**DO NOT STOP**
- 6 WALK OVER BRIDGE
- 7 WALK OVERS
- 8 LL LOPE OVER 2 LOGS-STOP
- 9 360 RIGHT OR LEFT-WALK OVERS

SATURDAY 8.7.23

#5056 GOLDEN SERIES LIMITED TRAIL

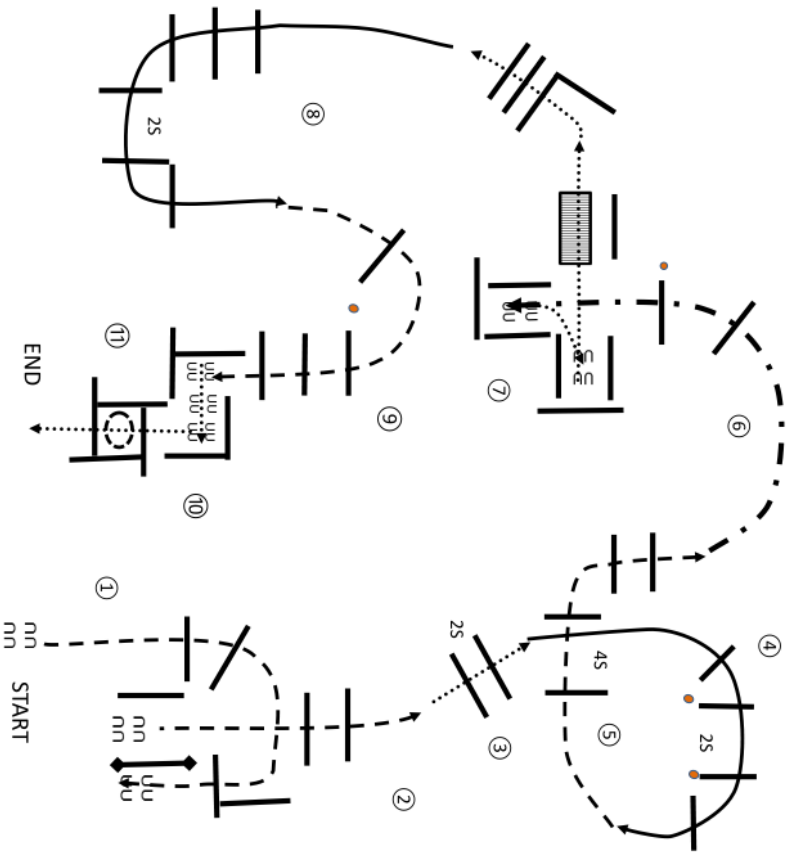

- 1 JOG OVERS TO GATE-STOP-RH
- 2 JOG OVERS
- 3 STOP OR BREAK TO A WALK-WALK OVERS
- 4 RL LOPE OVERS
- 5 JOG OVERS
- 6 EXTENDED TROT OVERS INTO CHUTE STOP
- 7 BACK OUT INTO CHUTE-WALK OUT OVER BRIDGE
- 8 LL LOPE OVERS
- 9 JOG OVERS THROUGH OPENING-STOP
- 10 SIDEPASS
- 11 WALK IN BOX-360 EITHER WAY-WALK OVER

ANNDENNISDESIGN COPYRIGHT 2023
ALL RIGHTS RESERVED

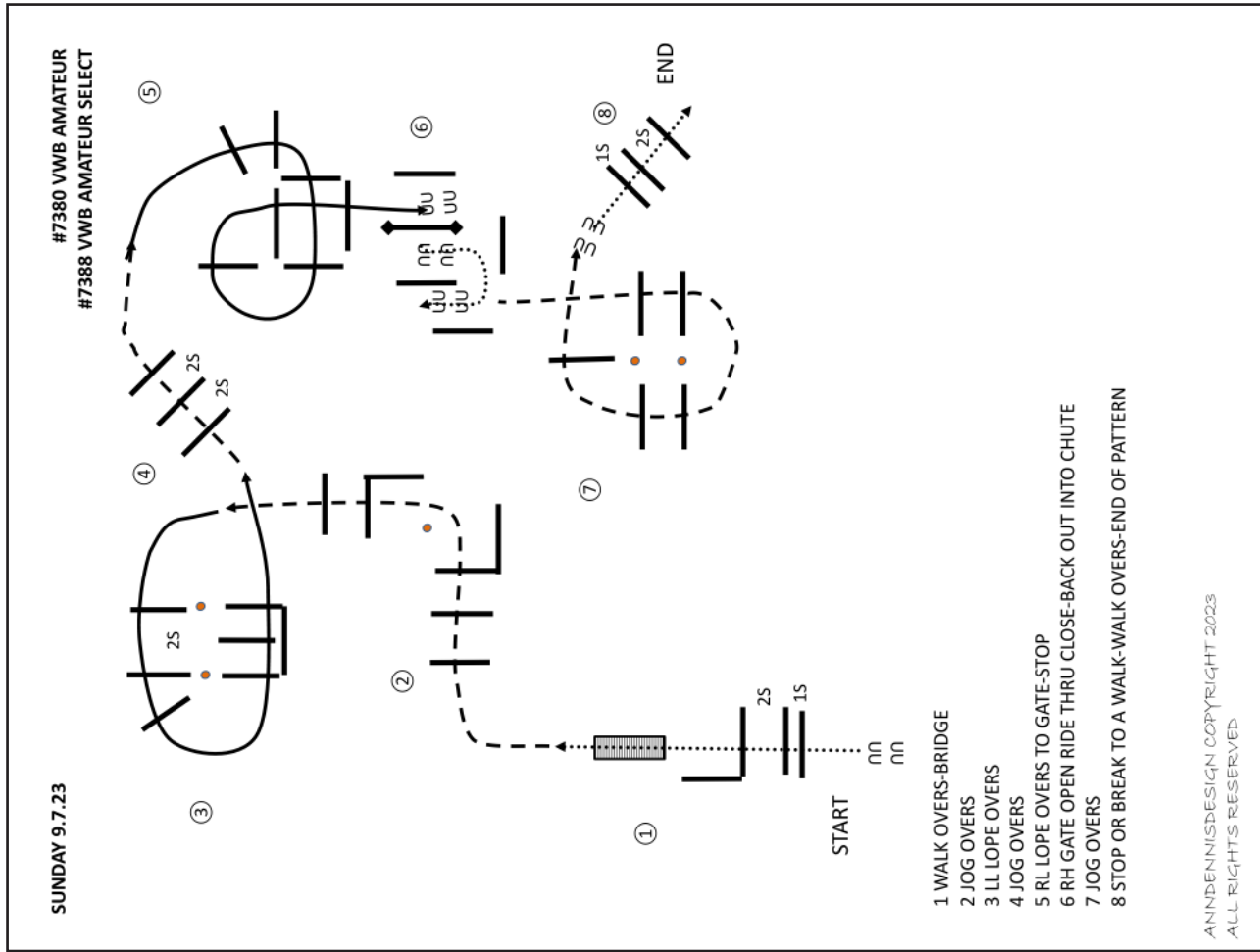
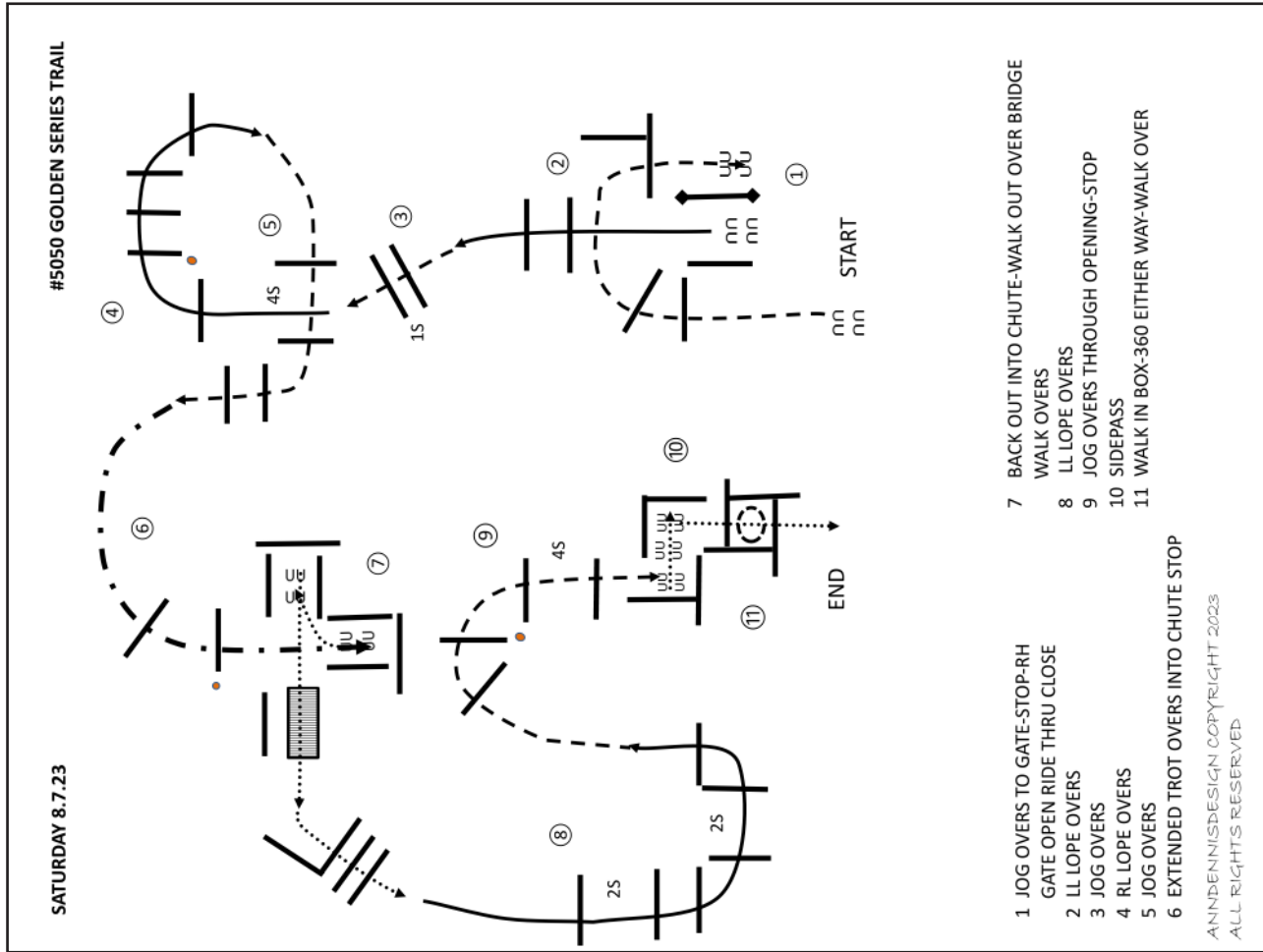

SUNDAY 9.7.23

#8388 VWB JUGEND TRAIL

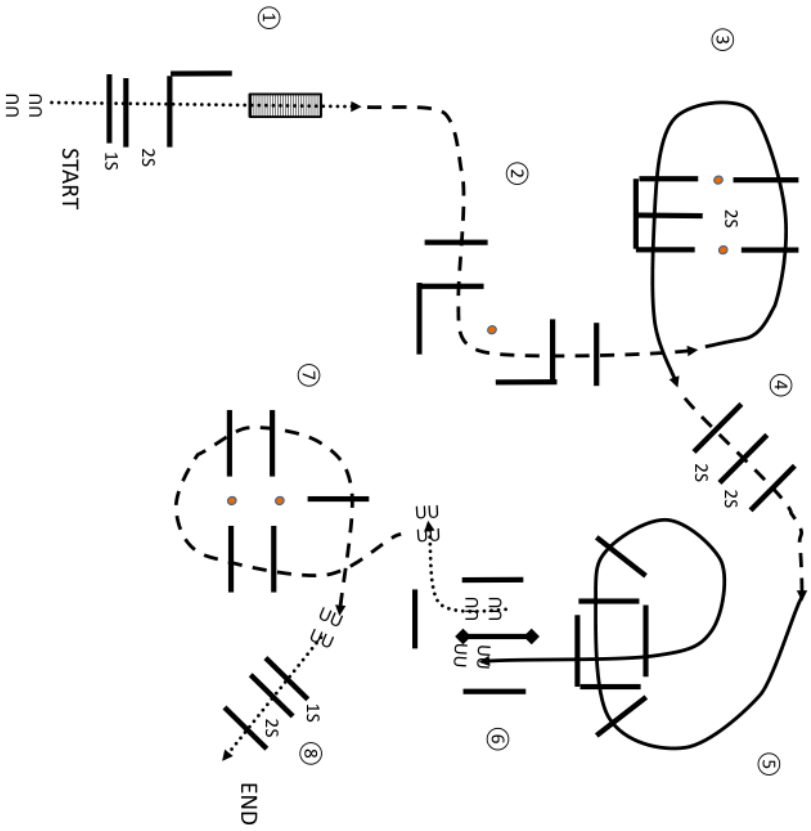

- 1 WALK OVERS-BRIDGE
- 2 JOG OVERS
- 3 LL LOPE OVERS
- 4 JOG OVERS
- 5 RL LOPE OVERS TO GATE-STOP
- 6 RH GATE OPEN RIDE THRU CLOSE-BACK L OUT FROM GATE
- 7 JOG OVERS
- 8 STOP OR BREAK TO A WALK-WALK OVERS-END OF PATTERN

ANNDENISDESIGN COPYRIGHT 2023
ALL RIGHTS RESERVED

SUNDAY 9.7.23

#8387 VWB NOVICE YOUTH TRAIL

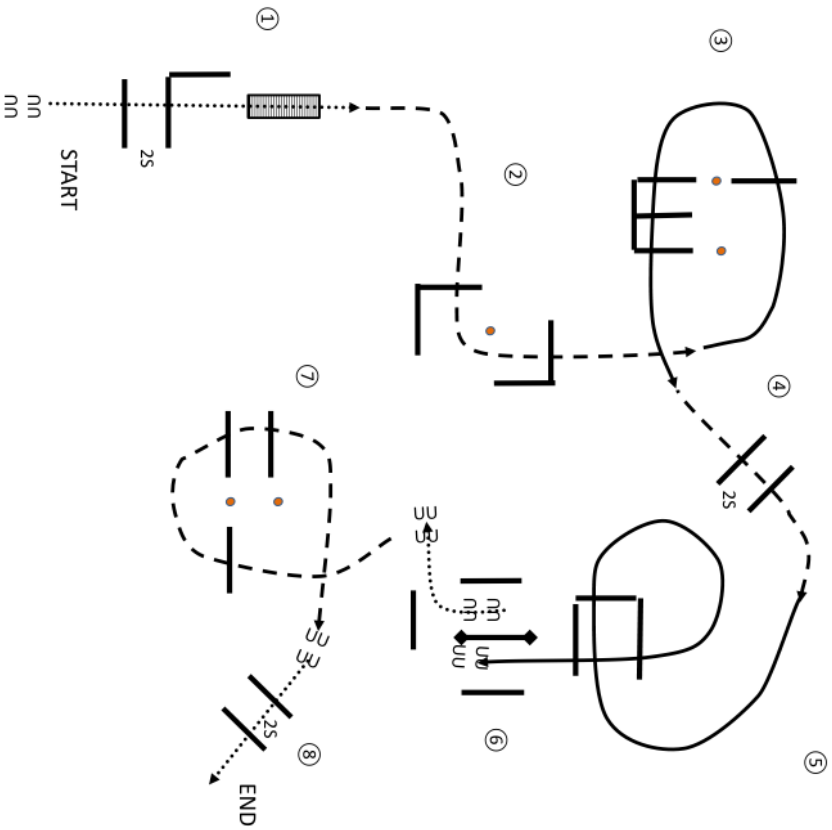

- 1 WALK OVERS-BRIDGE
- 2 JOG OVERS
- 3 LL LOPE OVERS
- 4 JOG OVERS
- 5 RL LOPE OVERS TO GATE-STOP
- 6 RH GATE OPEN RIDE THRU CLOSE-BACK L OUT FROM GATE
- 7 JOG OVERS
- 8 STOP OR BREAK TO A WALK-WALK OVERS-END OF PATTERN

ANNDENISDESIGN COPYRIGHT 2023
ALL RIGHTS RESERVED

SUNDAY 9.7.23 #9380 VWB EINSTEIGER TRAIL

- 1 WALK OVERS-BRIDGE
- 2 JOG OVERS
- 3 LL LOPE OVERS
- 4 JOG OVERS
- 5 RL LOPE OVERS TO GATE-STOP
- 6 RH GATE OPEN RIDE THRU CLOSE-BACK L OUT FROM GATE
- 7 JOG OVERS
- 8 STOP OR BREAK TO A WALK-WALK OVERS-END OF PATTERN

ANNDENNISDESIGN COPYRIGHT 2023
ALL RIGHTS RESERVED

SUNDAY 9.7.23 #7390 VWB RANCH TRAIL-AMATEUR

- 1 PICK UP ROPE-DAILY DRAG LOG RIGHT CIRCLE TROT OR WALK-PUT LOG BACK TO START
- 2 EXTENDED TROT PAST LOG-STOP AND BACK
- 3 SIDEPASS LOG LEFT
- 4 WALK OVER BRIDGE
- 5 TROT OVER 2 LOGS
- 6 RL LOPE TO GATE-STOP-RH GATE OPEN RIDE THRU CLOSE-TROT OUT
- 7 SERPENTINE TROT OVERS
- 8 LL LOPE OVER 1 LOG
- 9 BREAK TO A WALK-DO NOT STOP-WALK OVER 3 LOGS TO END PATTERN

6810 Showmanship VWB-Jungferde-Cup

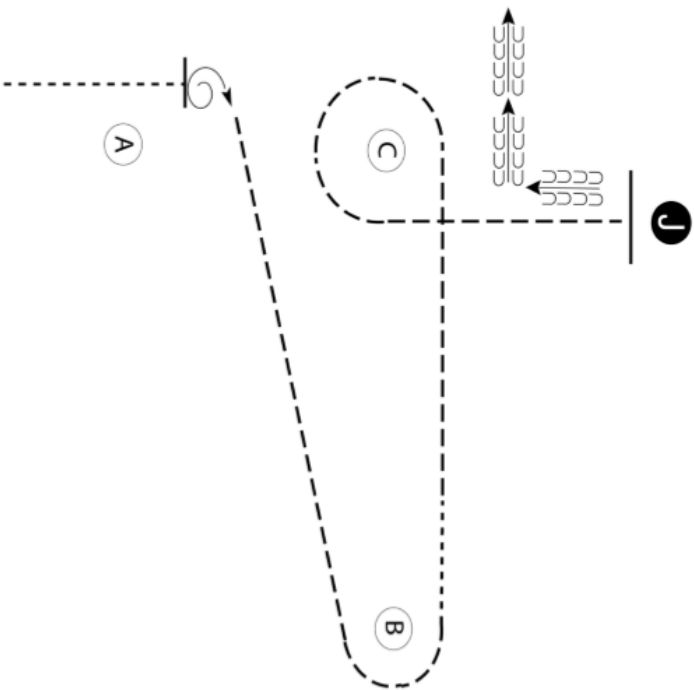

1. Begin before A. Walk past A and stop.
2. Perform a 405 degree turn.
3. Trot around B. At B walk 6 steps.
4. Trot to and around C to the Judge.
5. Stop and set up for inspection.
6. When dismissed back a corner and follow instructions of ring steward.

NOTE: The drawn description of this pattern is only intended for the general depictions of the pattern. Contestants should utilize the arena space to best exhibit their horses.

5052 Bavarian Golden Series Showmanship

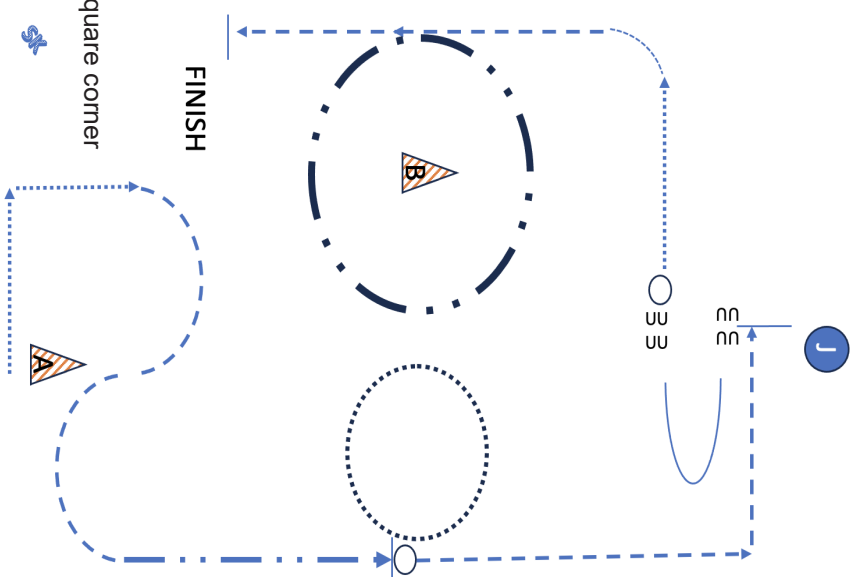

- Be ready at marker A
1. Walk and show a square corner
 2. Trot as drawn
 3. Extended trot, stop
 4. 360° turn
 5. Extended walk and show a circle
 6. Trot and perform a square corner, stop
 7. Set up with hips aligned with the judge
 8. Inspection
 9. When dismissed back U
 10. 1 1/2 turn
 11. Walk
 12. Trot and at the extended trot perform a circle around marker B
 13. Transition to trot and stop halfway between marker A and B

VWB 8127 Novice Jugend Showmanship
VWB 9120 Einsteiger Showmanship

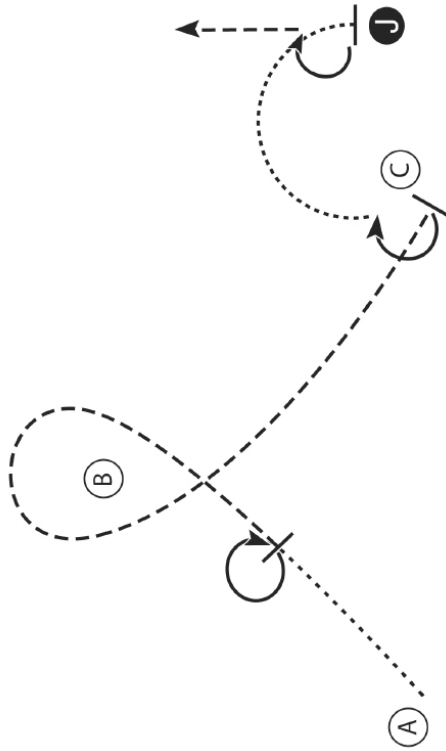

1. Walk A towards B.
2. When halfway to B stop and perform a 360 degree turn.
3. Trot to and around B and continue to C.
4. At C stop and perform a 225 degree turn.
5. Walk in a half circle to the judge.
6. Stop and set up for inspection.
7. When dismissed perform a 180 degree turn and trot straight away from the judge.

NOTE: The drawn description of this pattern is only intended for the general depictions of the pattern. Contestants should utilize the arena space to best exhibit their horses.

VWB 8128 Jugend Showmanship

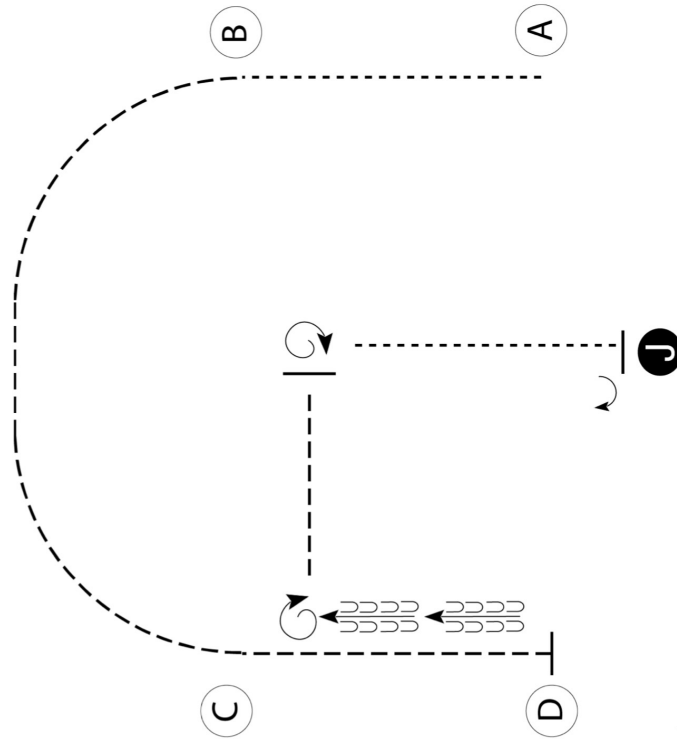

Be ready at A.

1. Walk from A to B then trot in an arc from B to C. Continue the trot from C to D.
2. Stop and back eight to ten feet (2,5 - 3 meter).
3. Perform a 270 degree turn, then trot, and stop.
4. Perform a 450 degree turn and walk to Judge and stop.
5. Set up for inspection.
6. When dismissed, perform a 90 degree turn and trot to exit.
7. Pattern is complete.

NOTE: The drawn description of this pattern is only intended for the general depictions of the pattern. Contestants should utilize the arena space to best exhibit their horses.

VWB 7120 Amateur Showmanship
 VWB 7128 Amateur Showmanship Select

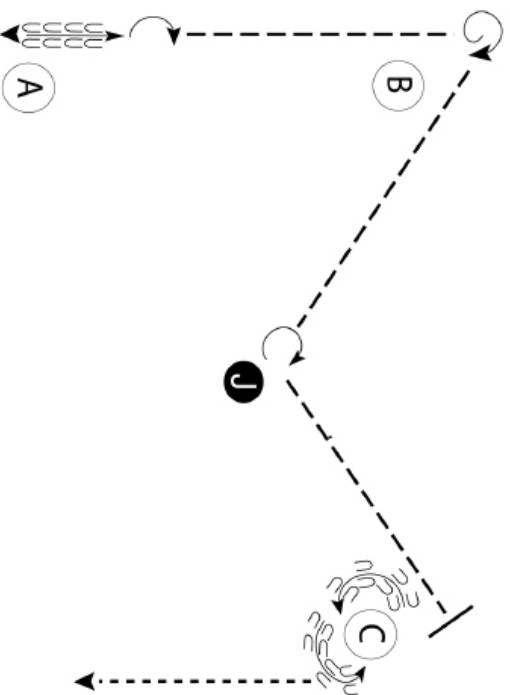

- Be ready at A facing away from B.
1. Back one horse length from A.
 2. Turn 180 degrees and trot past B.
 3. Stop past B, turn 1 1/3 turns and trot to judge.
 4. Stop and set up for inspection.
 5. When dismissed, do a 3/4 turn and trot to C.
 6. Stop at C. Back around C.
 7. Walk straight away from C to exit.

NOTE: The drawn description of this pattern is only intended for the general depictions of the pattern. Contestants should utilize the arena space to best exhibit their horses.

VWB 6120 Offen Showmanship

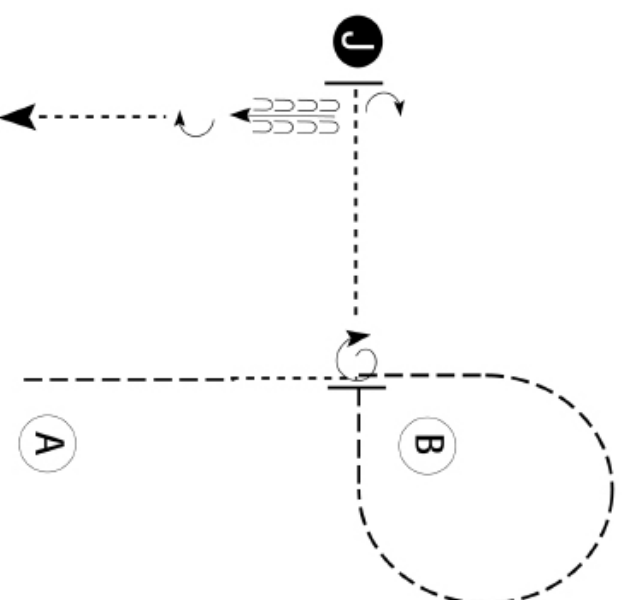

1. Trot halfway to B.
2. Walk two horse lengths.
3. Trot to and around B as shown.
4. Trot past B and stop. Perform a 360 degree turn.
5. Walk to judge and set up for inspection.
6. When dismissed, perform a 90 degree turn and back approximately 2 horse lengths.
7. Perform a 180 degree turn and walk straight away.

NOTE: The drawn description of this pattern is only intended for the general depictions of the pattern. Contestants should utilize the arena space to best exhibit their horses.

AQHA 4120 Youth Showmanship
 AQHA 3120 Novice Amateur Showmanship

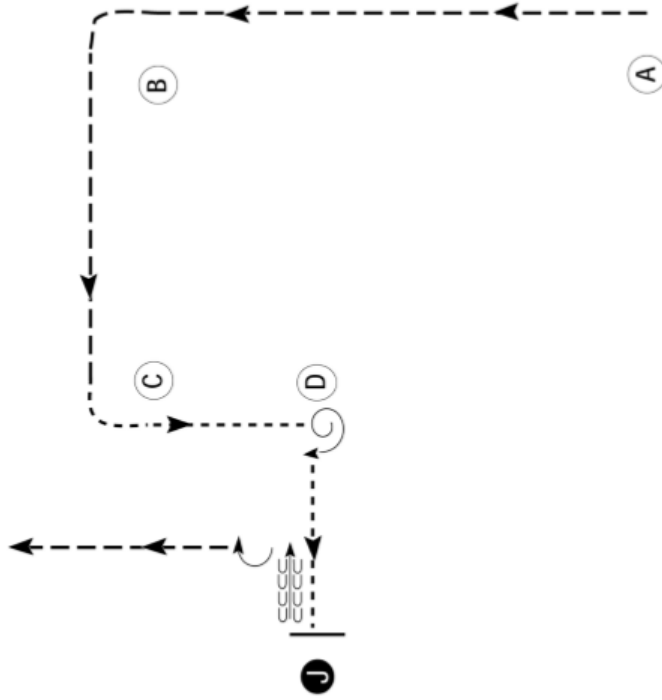

- Be ready at A.
1. Trot around B and to C.
 2. Break to a walk and walk around C to D.
 3. Turn 450 degrees and walk to Judge.
 4. Stop and set up for inspection.
 5. When dismissed, back approximately one horse length.
 6. Turn 90 degrees and trot away from judge.

NOTE: The drawn description of this pattern is only intended for the general depictions of the pattern. Contestants should utilize the arena space to best exhibit their horses.

AQHA 2120 Amateur Showmanship

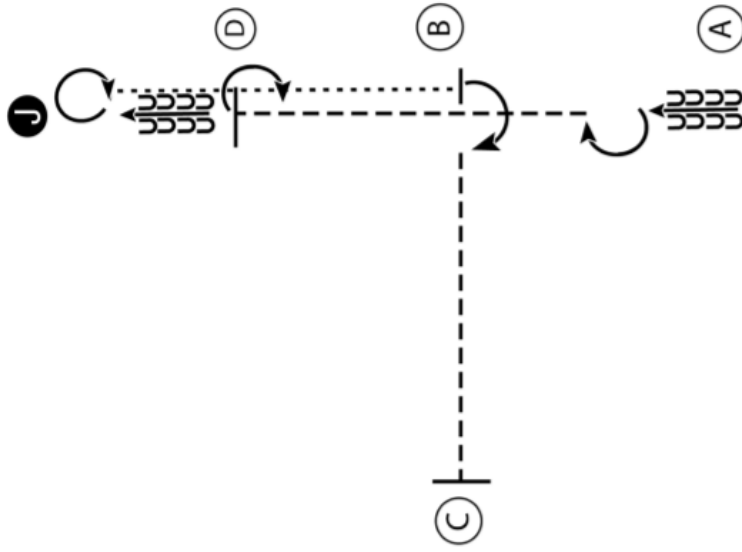

1. Begin facing away from the Judge. Back four steps.
2. Perform a 180 degree turn.
3. Trot to D. Perform a 180 degree turn.
4. Back to the Judge. Stop and set up for inspection.
5. When dismissed perform a 360 degree turn.
6. Walk to B. Stop and perform a 90 degree turn.
7. Trot to C, stop and wait for instructions from the ring steward.

NOTE: The drawn description of this pattern is only intended for the general depictions of the pattern. Contestants should utilize the arena space to best exhibit their horses.

WVB 8407 Novice Jugend Horsemanship

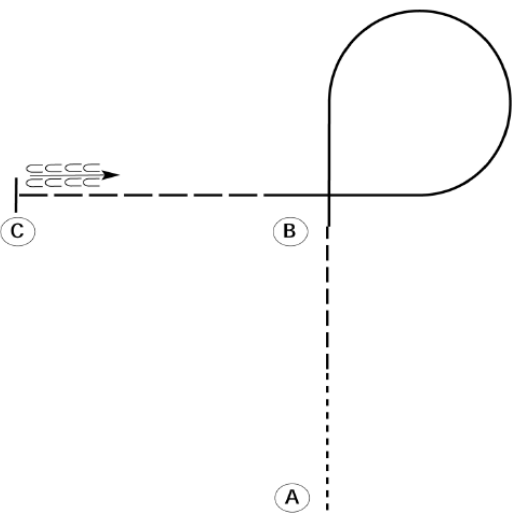

- Be ready at A.
1. Walk from A 1/2 way to B.
 2. Jog the rest of the way to B.
 3. Lope a circle to the right.
 4. Perform an extended jog from B to C.
 5. Stop at C and back one horse length.

NOTE: The drawn description of this pattern is only intended for the general depictions of the pattern. Contestants should utilize the arena space to best exhibit their horses.

8408 VWB Jugend Horsemanship 9120 VWB Einsteiger Horsemanship

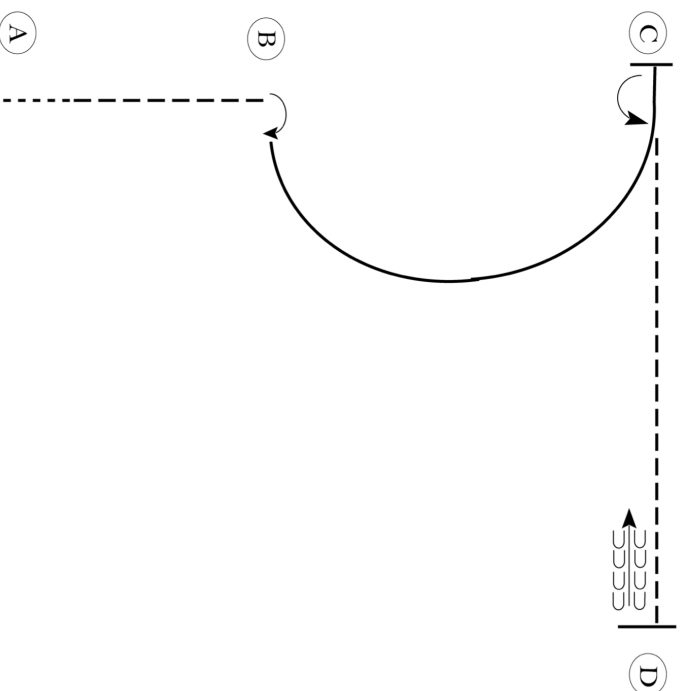

- Be ready before A.
1. Walk approximately 2 horse lengths from A.
 2. Jog to B.
 3. Turn 1/4 turn to the right.
 4. Lope on the left lead to C.
 5. Turn 1/2 turn to the left.
 6. Jog to D.
 7. Stop at D and back approximately one horse length.

NOTE: The drawn description of this pattern is only intended for the general depictions of the pattern. Contestants should utilize the arena space to best exhibit their horses.

VWB 7400 Amateur Horsemanship
VWB 7408 Amateur Horsemanship Select

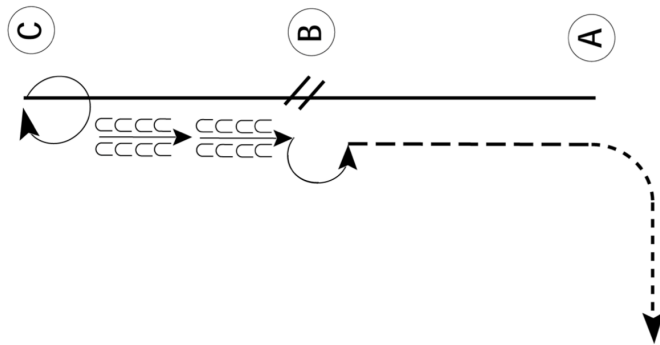

- Be ready before A.
1. Lope on the left lead to B.
 2. Perform a flying lead change at B.
 3. Lope on the right lead to C.
 4. Stop at C and perform a 360 degree turn to the right.
 5. Back to B.
 6. Turn 180 degrees to the left.
 7. Jog to A.
 8. Walk at A and turn the corner to the right.

NOTE: The drawn description of this pattern is only intended for the general depictions of the pattern. Contestants should utilize the arena space to best exhibit their horses.

AQHA 4400 Youth Horsemanship

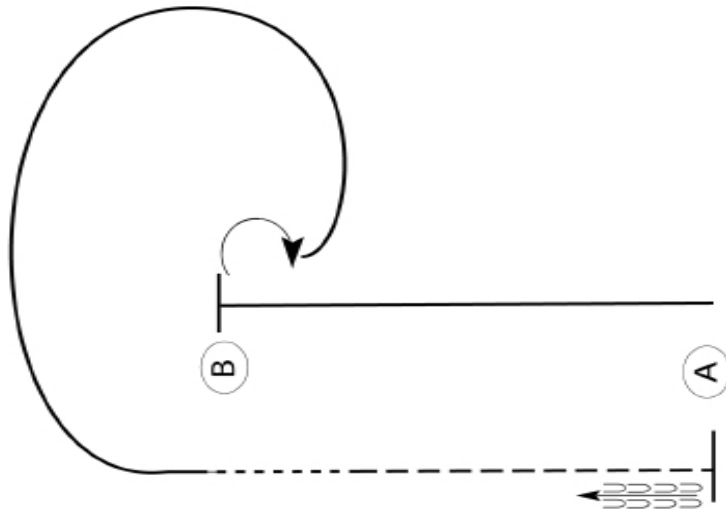

- Be ready at A.
1. Lope on the right lead to B.
 2. Turn 180 degrees to the right.
 3. Lope on the left lead back around to B.
 4. At B, break to the walk.
 5. Walk approximately 10 feet.
 6. Jog to A.
 7. Stop at A and back approximately one horse length.

NOTE: The drawn description of this pattern is only intended for the general depictions of the pattern. Contestants should utilize the arena space to best exhibit their horses.

AQHA 3400 Novice Amateur Horsemanship

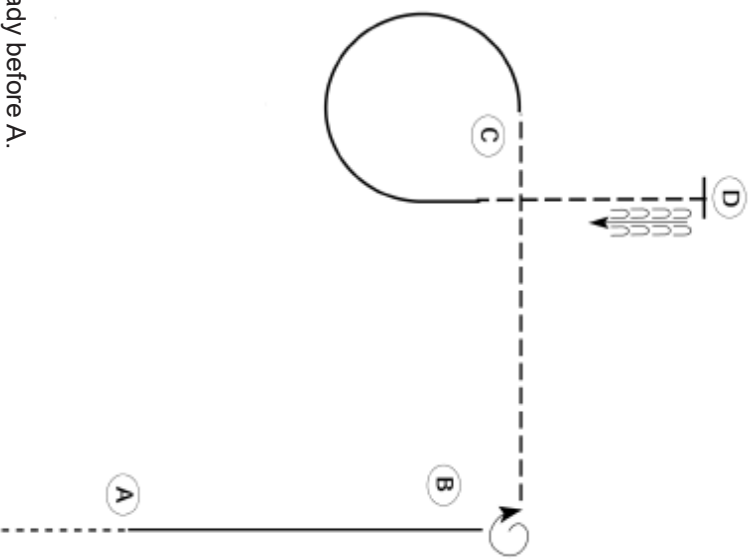

- Be ready before A.
1. Walk to A.
 2. Lope on the right lead past B.
 3. Spin 3/4 turns to the right.
 4. Jog from B to C.
 5. Lope a circle on the left lead around C.
 6. Jog from C to D.
 7. Stop at D and back approximately one horse length.

NOTE: The drawn description of this pattern is only intended for the general depictions of the pattern. Contestants should utilize the arena space to best exhibit their horses.

AQHA 2400 Amateur Horsemanship AQHA 2408 Amateur Select Horsemanship

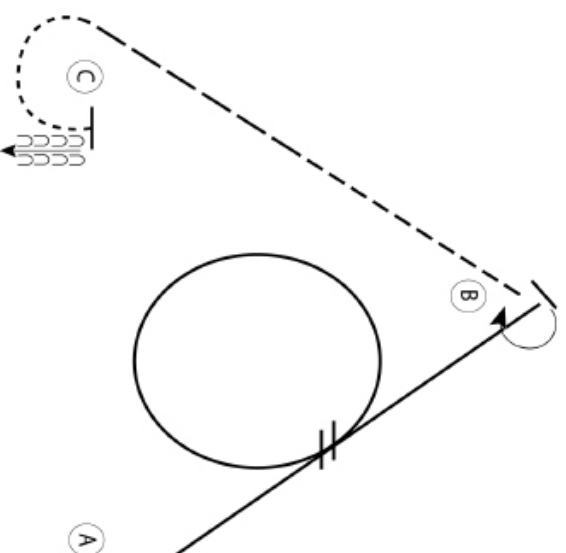

1. Lope on the left lead towards B.
2. Halfway between A and B lope a circle to the left on the left lead.
3. Half way between A and B perform a simple lead change.
4. Lope past B. Stop and perform a 225 degree turn to the right.
5. Jog towards C.
6. Halfway between B and C extend the jog.
7. At C walk, walk around C.
8. At C stop and back approximately one horse length.

5053 Bavarian Golden Series Horsemanship

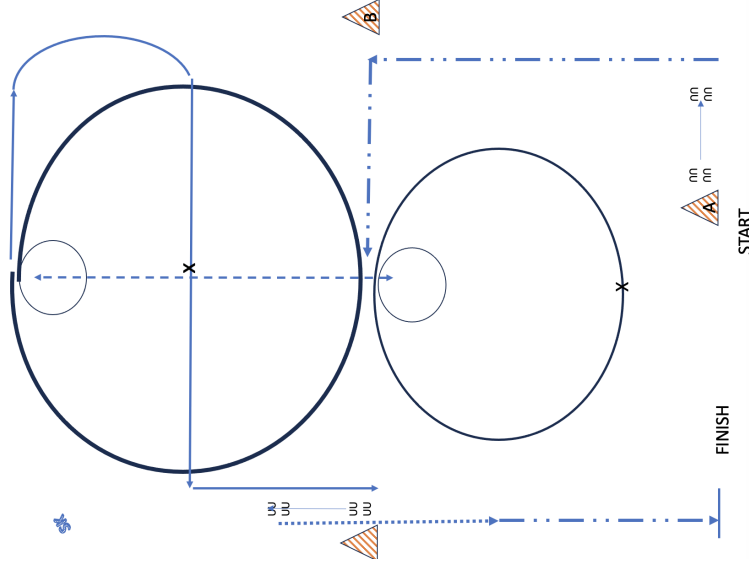

- Be ready at marker A
1. Sidepass to the right
 2. Drop your stirrups, extended trot and show a square corner
 3. Lope right lead (counter canter) 1/2 circle to the left, simple lead change through walk, lope 1/2 circle left lead, stop at the center, pick up stirrups
 4. Perform a 1/4 turn to the right
 5. Jog down the centerline
 6. Stop and perform a 1 3/4 turn to the left
 7. Lope right lead a large circle at the extended lope
 8. Collected lope and continue on the right lead
 9. Change leads (flying or simple) on the centerline
 10. Show a square corner
 11. Stop next to marker B
 12. Back up 2 horse lengths
 13. Extended walk, halfway
 14. Extended jog, stop

5054 Bavarian Golden Series Ranch Riding

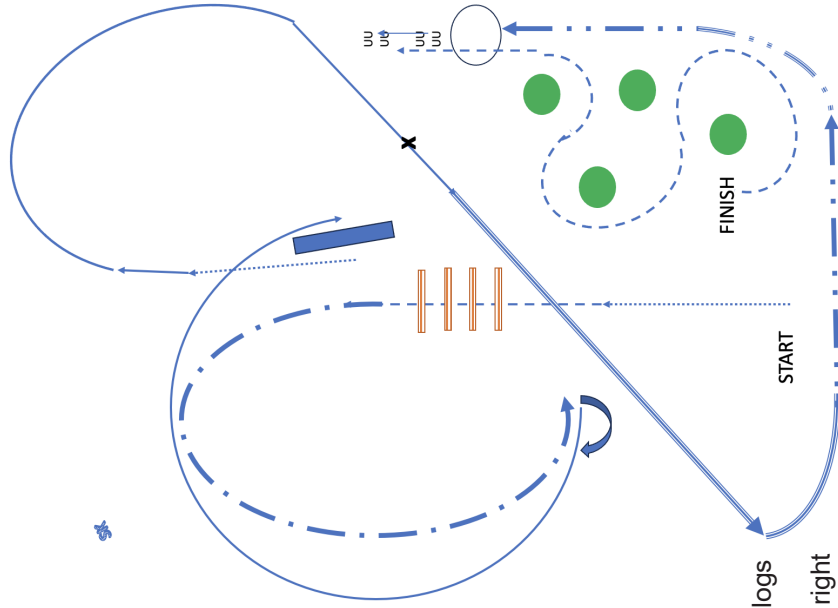

1. Walk
2. Trot and trot over logs
3. Extended trot
4. Stop and rollback right
5. Lope right lead
6. Stop and work gate
7. Walk
8. Lope right lead
9. Change leads (simple or flying)
10. Collected lope **left** lead and extended lope
11. Extended trot
12. Stop and perform 1 1/2 turn (left or right)
13. Back up
14. Trot around bushes or markers as drawn and stop

AQHA 3520 Novice Amateur Hunt Seat Equitation
 AQHA 4520 Youth Hunt Seat Equitation

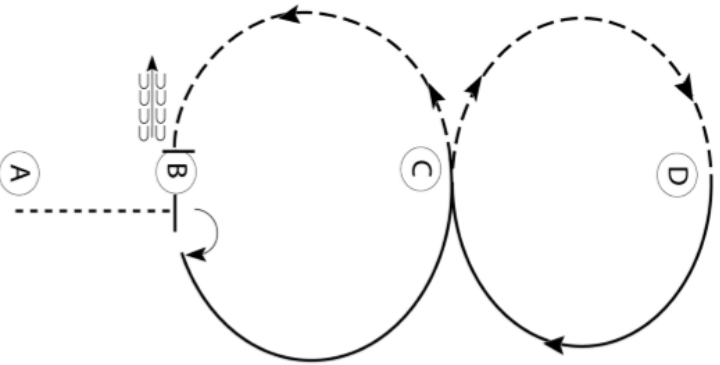

- Be ready at A.
1. Walk to B.
 2. Stop at B and perform a 90 degree turn to the right on the forehead.
 3. Canter on the left lead to C.
 4. Posting trot from C to D.
 5. Canter on the right lead from D to C.
 6. Posting trot from C to B.
 7. Stop at B and back one horse length.

NOTE: The drawn description of this pattern is only intended for the general depictions of the pattern. Contestants should utilize the arena space to best exhibit their horses.

AQHA 2520 Amateur Hunt Seat Equitation

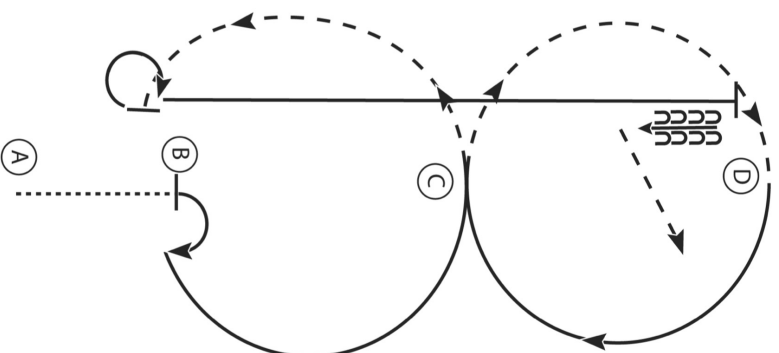

1. Walk A to B.
2. At B stop and perform a 90 degree turn to the right.
3. Canter on the left lead in a half circle to C.
4. At C posting trot in a half circle to D on the left diagonal.
5. At D counter canter on the left lead in a half circle to C,
6. At C posting trot a half circle to before B on the right diagonal.
7. Before B stop and perform a 270 degree turn to the right.
8. Hand gallop to D.
9. At D stop and back 4 steps.
10. Sitting trot to exit.

NOTE: The drawn description of this pattern is only intended for the general depictions of the pattern. Contestants should utilize the arena space to best exhibit their horses.